

# CHIP OVALE 25

Part number 005702

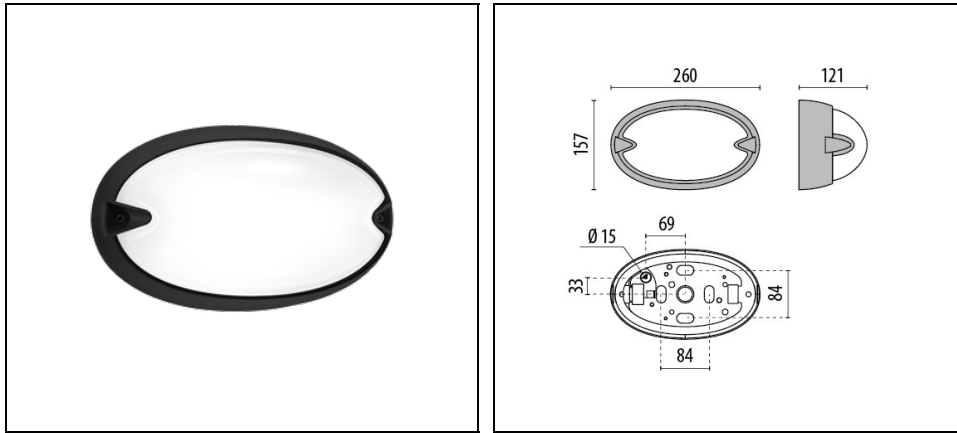

## Description

Series of ceiling, wall, bracket and post mounted luminaires for indoor and outdoor, comprising::

- Technopolymer housing, trim or screen
- Pressed glass diffuser, internally coated
- Aluminium reflector for E27 versions
- Anti-ageing custom moulded silicone sealing gasket(s)
- Stainless steel locking hardware
- Built-in driver
- Side entry for 20 mm conduits (drill out holes in housing arrangement)
- Anti-tampering screws available upon request
- Design by ROBERTO FIORATO
- Design by ROBERTO FIORATO

To maintain the regular updating of our products, PERFORMANCE iN LIGHTING reserves the right to make changes without prior notice. For the most up to date information we always recommend you read the latest version published on the website [www.performanceinlighting.com](http://www.performanceinlighting.com). Delivered luminaire lumen outputs and power consumptions, including losses, are subject to a tolerance of +/- 7%, and unless otherwise stated the values apply to an ambient temperature of 25°C. Terms of warranty are available at <https://www.performanceinlighting.com/qr/company/led-warranty>

## Product data

ETIM Group:	EG000027	ETIM Class:	EC0028g2
-------------	----------	-------------	----------

## General information

Lampholder:	E27	Light source:	Fluorescent lamps
Luminaire wattage [W]:	1x21 W	Colour / Finishing:	BK-81 / Black / Textured
IP degree of protection:	IP55	Impact resistance / impact energy:	IK06 1J xx3
Protection class:	II	Optic:	S/EW - Symmetric Extra-Wide
Net weight [kg]:	0.936	Overall length [mm]:	260
Overall width [mm]:	121	Overall height [mm]:	157

## Mechanical features

Shape:	Rectangular	Housing material:	Plastic
Diffuser material:	Glass	Glow wire test [°C]:	750 °C

## Installation

Application area:	Outdoor lighting	Mounting type:	Bulkhead
Min. ambient temperature [°C]:	-30	Max. ambient temperature [°C]:	45

## Light features

## Photometric data

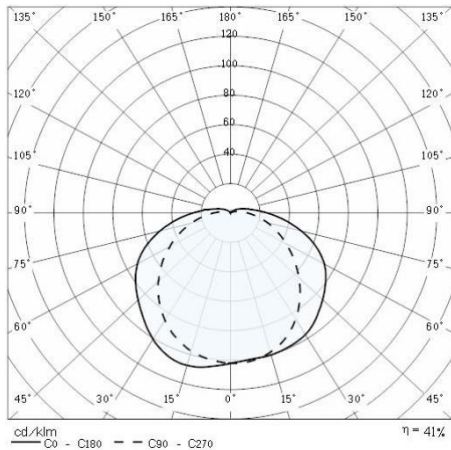

## Optional accessories

### CHIP OVALE 25

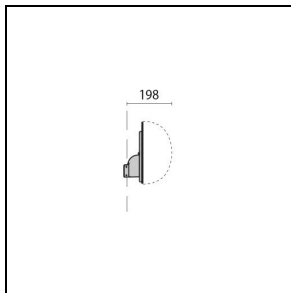

**000790**

Corner bracket (vertical mount)

■ BK-81 / Black

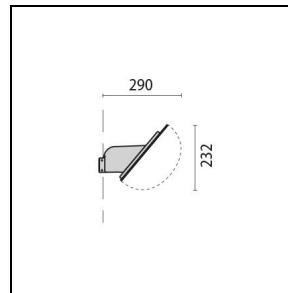

**000792**

Corner bracket (angled mount)

■ BK-81 / Black

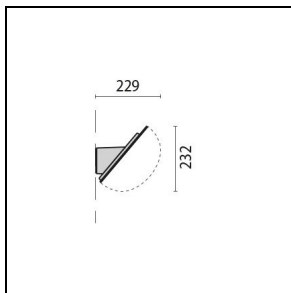

**000502**

Angled bracket 40°

■ BK-81 / Black

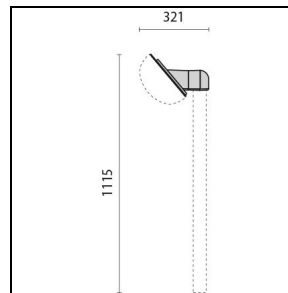

**000800**

Angled bracket for 42 mm post

■ BK-81 / Black

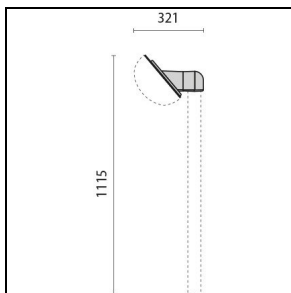

**000802**

Angled bracket for Ø 60 mm post

■ BK-81 / Black

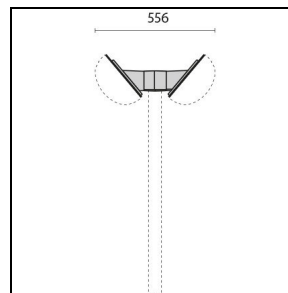

**000810**

Twin angled bracket for 60 mm post

■ BK-81 / Black

To maintain the regular updating of our products, PERFORMANCE IN LIGHTING reserves the right to make changes without prior notice. For the most up to date information we always recommend you read the latest version published on the website [www.performanceinlighting.com](http://www.performanceinlighting.com). Delivered luminaire lumen outputs and power consumptions, including losses, are subject to a tolerance of +/- 7%, and unless otherwise stated the values apply to an ambient temperature of 25°C. Terms of warranty are available at <https://www.performanceinlighting.com/qr/company/led-warranty>