

EKO+19 GRILL LED

Part number 301650

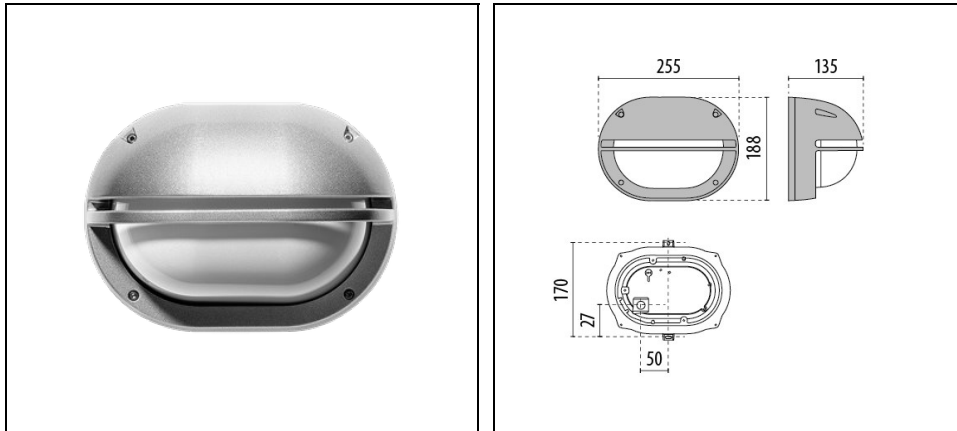

Description

Wall and ceiling mounted luminaire for indoor and outdoor, comprising:

- Die-cast aluminium housing, ring and screen, polyester powder coat finish ISO 9227/12944 - ISO 9223 (C5)
- Pressed glass diffuser, internally coated
- EPDM sealing gasket
- Diffuser stays securely hinged to the frame
- No through wiring
- Stainless steel locking hardware
- Design by ROBERTO FIORATO
- Design by ROBERTO FIORATO

To maintain the regular updating of our products, PERFORMANCE IN LIGHTING reserves the right to make changes without prior notice. For the most up to date information we always recommend you read the latest version published on the website www.performanceinlighting.com. Delivered luminaire lumen outputs and power consumptions, including losses, are subject to a tolerance of +/- 7%, and unless otherwise stated the values apply to an ambient temperature of 25°C. Terms of warranty are available at <https://www.performanceinlighting.com/qr/company/led-warranty>

Product data

ETIM Group:	EG000027	ETIM Class:	EC002892
-------------	----------	-------------	----------

General information

Lampholder:	LED	Light source:	LED
Lightsource lumen output [lm]:	738	Luminaire lumen output [lm]:	248
Luminaire wattage [W]:	10 W	Luminous efficacy [lm/W]:	25
CRI:	80	Colour temperature [K]:	4000
Colour / Finishing:	GR-20 / Metallic grey / Glossy	IP degree of protection:	IP66
Impact resistance / impact energy:	IK07 2J xx5	Protection class:	I
Optic:	A/EW - Asymmetric Extra-Wide	Net weight [kg]:	1.806
Overall length [mm]:	255	Overall width [mm]:	136
Overall height [mm]:	188		

Mechanical features

Shape:	Rectangular	Housing material:	Aluminium
Diffuser material:	Glass		

Electrical features

Voltage type:	AC/DC	Input voltage [V AC]:	220/240
Input frequency [Hz]:	0/50/60	Power factor / COS Φ :	>0.95
Input voltage [V DC]:	170/280	Surge protection Common [kV]:	4.000000
Inrush current [A/ μ s]:	5 / 50	C10 1.5 mm ² :	52
C16 2.5 mm ² :	85	B10 1.5 mm ² :	31
B16 2.5 mm ² :	50		

Installation

Application area:	Outdoor lighting	Mounting type:	Bulkhead
Min. ambient temperature [°C]:	-25	Max. ambient temperature [°C]:	40

Light features

MacAdam:	3	Lumen maintenance:	L80B10@50000h
Distribution of light emission:	Direct		

To maintain the regular updating of our products, PERFORMANCE IN LIGHTING reserves the right to make changes without prior notice. For the most up to date information we always recommend you read the latest version published on the website www.performanceinlighting.com. Delivered luminaire lumen outputs and power consumptions, including losses, are subject to a tolerance of +/- 7%, and unless otherwise stated the values apply to an ambient temperature of 25°C. Terms of warranty are available at <https://www.performanceinlighting.com/qr/company/led-warranty>

Photometric data

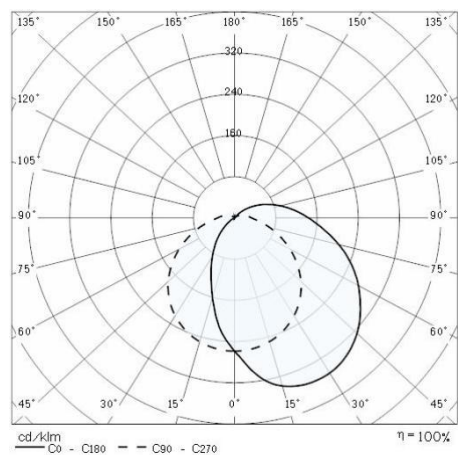

To maintain the regular updating of our products, PERFORMANCE IN LIGHTING reserves the right to make changes without prior notice. For the most up to date information we always recommend you read the latest version published on the website www.performanceinlighting.com. Delivered luminaire lumen outputs and power consumptions, including losses, are subject to a tolerance of +/- 7%, and unless otherwise stated the values apply to an ambient temperature of 25°C. Terms of warranty are available at <https://www.performanceinlighting.com/qr/company/led-warranty>