

# CHIP OVALE 25 LED GRILL

Part number 3100142

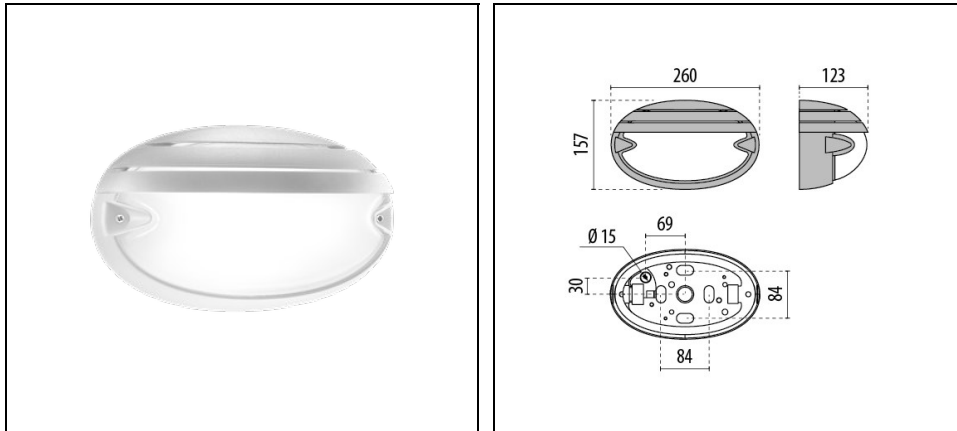

## Description

Wall, ceiling, bracket and post mounted luminaire for indoor and outdoor, comprising:

- Technopolymer housing, trim or screen
- Pressed glass diffuser, internally coated
- Anti-ageing custom moulded silicone sealing gasket(s)
- Stainless steel locking hardware
- Built-in driver
- Side entry for 20 mm conduits (drill out holes in housing arrangement)
- Anti-tampering screws available upon request
- Design by ROBERTO FIORATO
- Design by ROBERTO FIORATO

To maintain the regular updating of our products, PERFORMANCE IN LIGHTING reserves the right to make changes without prior notice. For the most up to date information we always recommend you read the latest version published on the website [www.performanceinlighting.com](http://www.performanceinlighting.com). Delivered luminaire lumen outputs and power consumptions, including losses, are subject to a tolerance of +/- 7%, and unless otherwise stated the values apply to an ambient temperature of 25°C. Terms of warranty are available at <https://www.performanceinlighting.com/qr/company/led-warranty>

## Product data

ETIM Group:	EG000027	ETIM Class:	EC002892
-------------	----------	-------------	----------

## General information

Lampholder:	LED	Light source:	LED
Lightsource lumen output [lm]:	930	Luminaire lumen output [lm]:	354
Luminaire wattage [W]:	6.5 W	Luminous efficacy [lm/W]:	54
CRI:	80	Colour temperature [K]:	4000
Colour / Finishing:	WH-87 / White / Textured	IP degree of protection:	IP55
Impact resistance / impact energy:	IK06 1J xx3	Protection class:	I
Optic:	A/EW - Asymmetric Extra-Wide	Net weight [kg]:	1.057
Overall length [mm]:	260	Overall width [mm]:	123
Overall height [mm]:	157		

## Mechanical features

Shape:	Oval	Housing material:	Plastic
Diffuser material:	Glass	Glow wire test [°C]:	750 °C

## Electrical features

Voltage type:	AC	Input voltage [V AC]:	220/240
Input frequency [Hz]:	50/60	Power factor / COS Φ:	>0.9
Inrush current [A/μs]:	5 / 25	C10 1.5 mm <sup>2</sup> :	64
C16 2.5 mm <sup>2</sup> :	103	B10 1.5 mm <sup>2</sup> :	64
B16 2.5 mm <sup>2</sup> :	103		

## Installation

Application area:	Outdoor lighting	Mounting type:	Bulkhead
Min. ambient temperature [°C]:	-20	Max. ambient temperature [°C]:	35

## Light features

MacAdam:	3	Lumen maintenance:	L80B10@6000h
Distribution of light emission:	Direct		

To maintain the regular updating of our products, PERFORMANCE IN LIGHTING reserves the right to make changes without prior notice. For the most up to date information we always recommend you read the latest version published on the website [www.performanceinlighting.com](http://www.performanceinlighting.com). Delivered luminaire lumen outputs and power consumptions, including losses, are subject to a tolerance of +/- 7%, and unless otherwise stated the values apply to an ambient temperature of 25°C. Terms of warranty are available at <https://www.performanceinlighting.com/qr/company/led-warranty>

## Photometric data

---

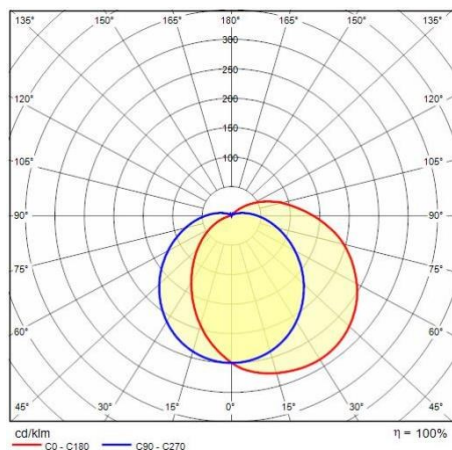

---

To maintain the regular updating of our products, PERFORMANCE IN LIGHTING reserves the right to make changes without prior notice. For the most up to date information we always recommend you read the latest version published on the website [www.performanceinlighting.com](http://www.performanceinlighting.com). Delivered luminaire lumen outputs and power consumptions, including losses, are subject to a tolerance of +/- 7%, and unless otherwise stated the values apply to an ambient temperature of 25°C. Terms of warranty are available at <https://www.performanceinlighting.com/qr/company/led-warranty>