

CHIP OVALE 30 LED

Part number 3100147

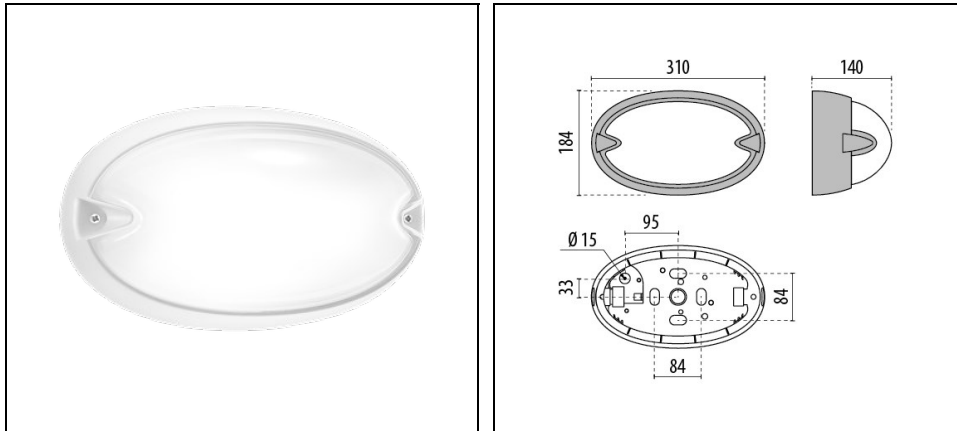

Description

Wall, ceiling, bracket and post mounted luminaire for indoor and outdoor, comprising:

- Technopolymer housing, trim or screen
- Pressed glass diffuser, internally coated
- Anti-ageing custom moulded silicone sealing gasket(s)
- Stainless steel locking hardware
- Built-in driver
- Side entry for 20 mm conduits (drill out holes in housing arrangement)
- Anti-tampering screws available upon request
- Design by ROBERTO FIORATO
- Design by ROBERTO FIORATO

To maintain the regular updating of our products, PERFORMANCE IN LIGHTING reserves the right to make changes without prior notice. For the most up to date information we always recommend you read the latest version published on the website www.performanceinlighting.com. Delivered luminaire lumen outputs and power consumptions, including losses, are subject to a tolerance of +/- 7%, and unless otherwise stated the values apply to an ambient temperature of 25°C. Terms of warranty are available at <https://www.performanceinlighting.com/qr/company/led-warranty>

Product data

ETIM Group:	EG000027	ETIM Class:	EC002892
-------------	----------	-------------	----------

General information

Lampholder:	LED	Light source:	LED
Lightsource lumen output [lm]:	1736	Luminaire lumen output [lm]:	994
Luminaire wattage [W]:	11.5 W	Luminous efficacy [lm/W]:	86
CRI:	80	Colour temperature [K]:	3000
Colour / Finishing:	WH-87 / White / Textured	IP degree of protection:	IP55
Impact resistance / impact energy:	IK06 1J xx3	Protection class:	I
Optic:	S/EW - Symmetric Extra-Wide	Net weight [kg]:	1.532
Overall length [mm]:	310	Overall width [mm]:	140
Overall height [mm]:	184		

Mechanical features

Shape:	Oval	Housing material:	Plastic
Diffuser material:	Glass	Glow wire test [°C]:	750 °C

Electrical features

Voltage type:	AC/DC	Input voltage [V AC]:	220/240
Input frequency [Hz]:	0/50/60	Power factor / COS Φ:	>0.9
Input voltage [V DC]:	170/280	Surge protection Common [kV]:	4.000000
Inrush current [A/μs]:	5 / 50	C10 1.5 mm ² :	52
C16 2.5 mm ² :	85	B10 1.5 mm ² :	31
B16 2.5 mm ² :	50		

Installation

Application area:	Outdoor lighting	Mounting type:	Bulkhead
Min. ambient temperature [°C]:	-20	Max. ambient temperature [°C]:	25

Light features

MacAdam:	3	Lumen maintenance:	L80B10@60000h
Distribution of light emission:	Direct		

To maintain the regular updating of our products, PERFORMANCE iN LIGHTING reserves the right to make changes without prior notice. For the most up to date information we always recommend you read the latest version published on the website www.performanceinlighting.com. Delivered luminaire lumen outputs and power consumptions, including losses, are subject to a tolerance of +/- 7%, and unless otherwise stated the values apply to an ambient temperature of 25°C. Terms of warranty are available at <https://www.performanceinlighting.com/qr/company/led-warranty>

Photometric data

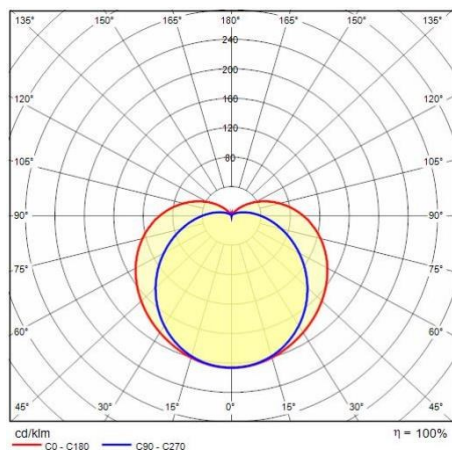

To maintain the regular updating of our products, PERFORMANCE IN LIGHTING reserves the right to make changes without prior notice. For the most up to date information we always recommend you read the latest version published on the website www.performanceinlighting.com. Delivered luminaire lumen outputs and power consumptions, including losses, are subject to a tolerance of +/- 7%, and unless otherwise stated the values apply to an ambient temperature of 25°C. Terms of warranty are available at <https://www.performanceinlighting.com/qr/company/led-warranty>