

EKO 21

Part number 3100217

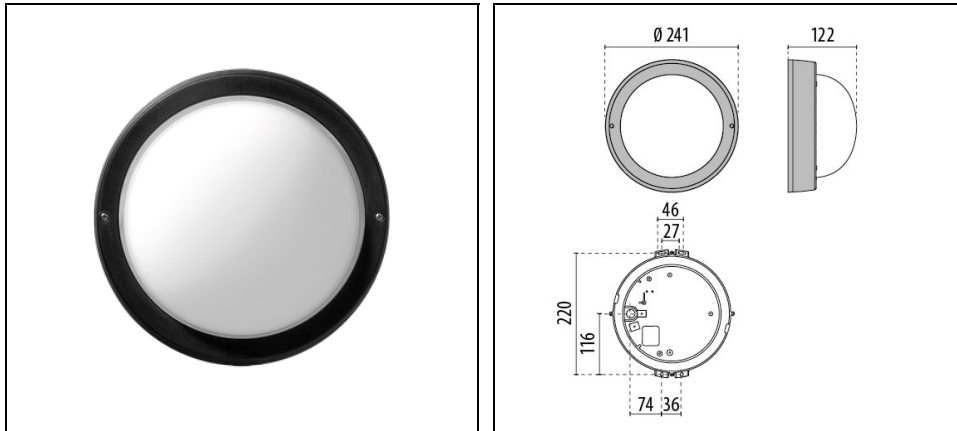

Description

Series of wall and ceiling mounted luminaire for indoor and outdoor, comprising::

- Technopolymer housing, ring and screen
- Pressed glass diffuser, internally coated
- Aluminium reflector for E27 versions
- Integral, tiltable, self-heat dissipating, Metal-Core SMD LED board (future proof)
- Built-in driver
- Stainless steel locking hardware
- Anti-tampering locking kit available as accessory
- All versions are available with polycarbonate diffuser IK10 upon request
- Design by ROBERTO FIORATO

To maintain the regular updating of our products, PERFORMANCE IN LIGHTING reserves the right to make changes without prior notice. For the most up to date information we always recommend you read the latest version published on the website www.performanceinlighting.com. Delivered luminaire lumen outputs and power consumptions, including losses, are subject to a tolerance of +/- 7%, and unless otherwise stated the values apply to an ambient temperature of 25°C. Terms of warranty are available at <https://www.performanceinlighting.com/qr/company/led-warranty>

Product data

ETIM Group:	EG000027	ETIM Class:	EC002892
-------------	----------	-------------	----------

General information

Lampholder:	LED	Light source:	LED
Lightsource lumen output [lm]:	1281	Luminaire lumen output [lm]:	1086
Luminaire wattage [W]:	11.5 W	Luminous efficacy [lm/W]:	94
CRI:	80	Colour temperature [K]:	4000
Colour / Finishing:	BK-81 / Black / Textured	IP degree of protection:	IP44
Impact resistance / impact energy:	IK06 1J xx3	Protection class:	I
Optic:	S/EW - Symmetric Extra-Wide	Net weight [kg]:	1.269
Overall diameter [mm]:	241	Overall width [mm]:	122

Mechanical features

Shape:	Round $150 \leq x \leq 300$ mm	Housing material:	Plastic
Diffuser material:	Glass	Glow wire test [°C]:	750 °C

Electrical features

Voltage type:	AC/DC	Input voltage [V AC]:	220/240
Input frequency [Hz]:	0/50/60	Power factor / COS Φ :	>0.9
Input voltage [V DC]:	170/276	Inrush current [A/ μ s]:	5 / 50
C10 1.5 mm ² :	52	C16 2.5 mm ² :	85
B10 1.5 mm ² :	31	B16 2.5 mm ² :	50

Installation

Application area:	Outdoor lighting	Mounting type:	Bulkhead
Min. ambient temperature [°C]:	-20	Max. ambient temperature [°C]:	35

Light features

MacAdam:	3	Lumen maintenance:	L80B10@60000h
Distribution of light emission:	Direct		

To maintain the regular updating of our products, PERFORMANCE IN LIGHTING reserves the right to make changes without prior notice. For the most up to date information we always recommend you read the latest version published on the website www.performanceinlighting.com. Delivered luminaire lumen outputs and power consumptions, including losses, are subject to a tolerance of +/- 7%, and unless otherwise stated the values apply to an ambient temperature of 25°C. Terms of warranty are available at <https://www.performanceinlighting.com/qr/company/led-warranty>

Photometric data

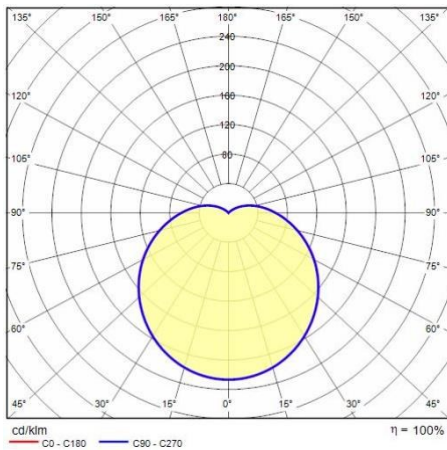

Optional accessories

EKO 21/26



310176
Anti-tamper



310177
Anti-tamper

To maintain the regular updating of our products, PERFORMANCE IN LIGHTING reserves the right to make changes without prior notice. For the most up to date information we always recommend you read the latest version published on the website www.performanceinlighting.com. Delivered luminaire lumen outputs and power consumptions, including losses, are subject to a tolerance of +/- 7%, and unless otherwise stated the values apply to an ambient temperature of 25°C. Terms of warranty are available at <https://www.performanceinlighting.com/qr/company/led-warranty>