

ACRO+ EQ258

Part number 3103934

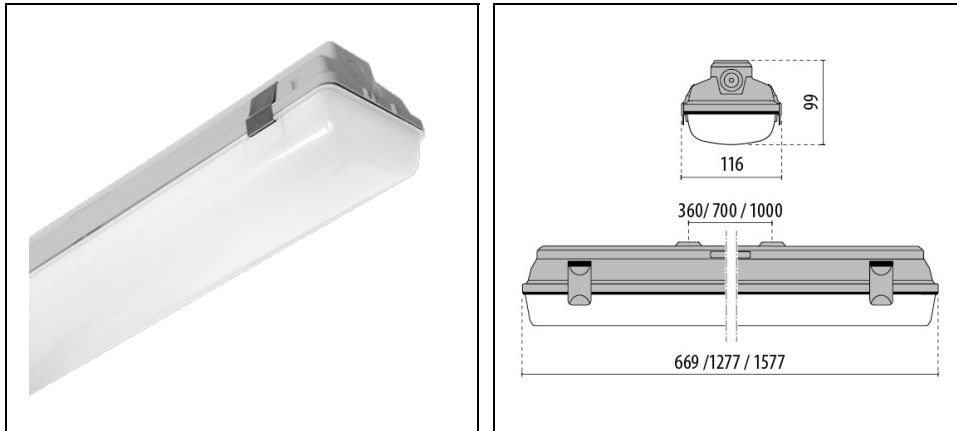

Description

Weatherproof LED luminaire, comprising:

- Fibreglass reinforced polyester housing
- Opal PMMA diffuser for optimal light distribution and uniformity
- Anti-ageing custom moulded silicone sealing gasket(s)
- 4000K multi-chip LED board
- Stainless steel retaining clips
- Quick ceiling fixing bracket (stainless steel)
- Integral Dip-Switches to select one of four power levels, which can be field adjusted (MULTIPOWER models)
- Suitable for extreme operating temp. conditions , -40°C (EXTREME options only)
- Emergency and extreme versions have a polycarbonate diffuser, 850°C glow wire

To maintain the regular updating of our products, PERFORMANCE IN LIGHTING reserves the right to make changes without prior notice. For the most up to date information we always recommend you read the latest version published on the website www.performanceinlighting.com. Delivered luminaire lumen outputs and power consumptions, including losses, are subject to a tolerance of +/- 7%, and unless otherwise stated the values apply to an ambient temperature of 25°C. Terms of warranty are available at <https://www.performanceinlighting.com/qr/company/led-warranty>

Product data

ETIM Group:	EG000027	ETIM Class:	EC002892
-------------	----------	-------------	----------

General information

Lampholder:	LED	Light source:	LED
Luminaire lumen output [lm]:	6500	Luminaire wattage [W]:	59 W
Luminous efficacy [lm/W]:	110	CRI:	80
Colour temperature [K]:	4000	Colour / Finishing:	GR-RAL7035 / Grey RAL7035 / Matt
IP degree of protection:	IP66	Impact resistance / impact energy:	IK03 0.35J xx1
Protection class:	I	Optic:	S/EW - Symmetric Extra-Wide
Net weight [kg]:	2.7	Overall length [mm]:	1577
Overall width [mm]:	116	Overall height [mm]:	99

Mechanical features

Shape:	Rectangular	Housing material:	Plastic
Diffuser material:	Plastic	Glow wire test [°C]:	650 °C

Electrical features

Voltage type:	AC/DC	Input voltage [V AC]:	220/240
Input frequency [Hz]:	0/50/60	Power factor / COS Φ:	>0.9
Input voltage [V DC]:	176/276	Inrush current [A/μs]:	41 / 124
C10 1.5 mm ² :	26	C16 2.5 mm ² :	43
B10 1.5 mm ² :	16	B16 2.5 mm ² :	26

Installation

Application area:	Indoor lighting	Mounting type:	Waterproof
Min. ambient temperature [°C]:	-25	Max. ambient temperature [°C]:	35

Light features

MacAdam:	3	Lumen maintenance:	L70B50@60000h
Distribution of light emission:	Direct	UGR max.:	19.6

To maintain the regular updating of our products, PERFORMANCE iN LIGHTING reserves the right to make changes without prior notice. For the most up to date information we always recommend you read the latest version published on the website www.performanceinlighting.com. Delivered luminaire lumen outputs and power consumptions, including losses, are subject to a tolerance of +/- 7%, and unless otherwise stated the values apply to an ambient temperature of 25°C. Terms of warranty are available at <https://www.performanceinlighting.com/qr/company/led-warranty>

Photometric data

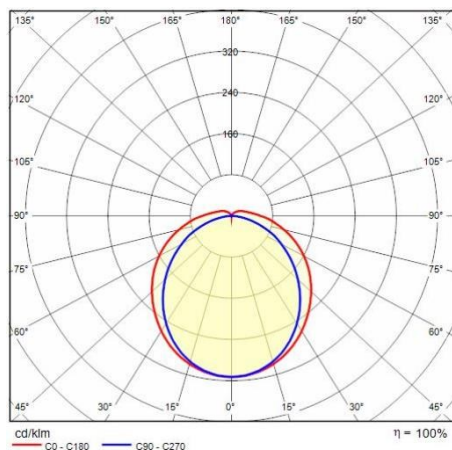

To maintain the regular updating of our products, PERFORMANCE IN LIGHTING reserves the right to make changes without prior notice. For the most up to date information we always recommend you read the latest version published on the website www.performanceinlighting.com. Delivered luminaire lumen outputs and power consumptions, including losses, are subject to a tolerance of +/- 7%, and unless otherwise stated the values apply to an ambient temperature of 25°C. Terms of warranty are available at <https://www.performanceinlighting.com/qr/company/led-warranty>