

DL ROUND MAXI

Part number 3108981

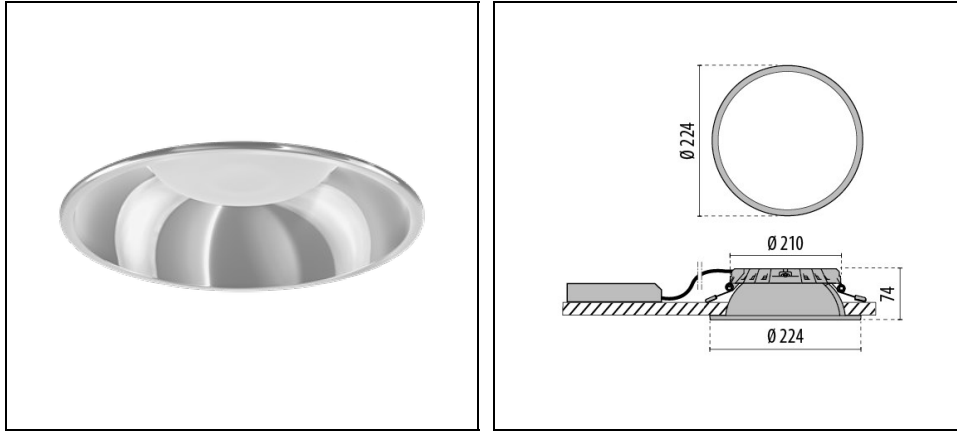

Description

Recessed, modular, LED downlight for indoor, comprising:

- LED module, die-cast aluminium heat sink, reflector with integrated ceiling trim, diffuser and external supply unit
- All components can be tool-less replaced lately
- Integrated diffuser grants an optimised uniformity
- Die-cast aluminium heat sink with Fast™ (Flexible air stream technology) cooling system grants an excellent dissipation and thermal management
- Built-in driver
- DALI dimmable
- Suitable for ceiling tile thickness from 1-25 mm
- Quick and toolless installation

Options:

- High-shine modular radial louvre reflector with integrated ceiling frame made of metallised injection-moulded ABS with light-tight connection to LED module
- Injection-moulded ABS reflector with integral ceiling trim with light-tight connection to LED module and matte plastic pane (IP54)

To maintain the regular updating of our products, PERFORMANCE iN LIGHTING reserves the right to make changes without prior notice. For the most up to date information we always recommend you read the latest version published on the website www.performanceinlighting.com. Delivered luminaire lumen outputs and power consumptions, including losses, are subject to a tolerance of +/- 7%, and unless otherwise stated the values apply to an ambient temperature of 25°C. Terms of warranty are available at <https://www.performanceinlighting.com/qr/company/led-warranty>

Product data

ETIM Group:	EG000027	ETIM Class:	EC001744
-------------	----------	-------------	----------

General information

Lampholder:	LED	Light source:	LED
Lightsource lumen output [lm]:	3500	Luminaire lumen output [lm]:	3130
Luminaire wattage [W]:	21 W	Luminous efficacy [lm/W]:	149
CRI:	80	Colour temperature [K]:	4000
Colour / Finishing:	SL-10 / Silver / Textured	IP degree of protection:	IP20
IP above/below ceiling:	IP20/IP44	Impact resistance / impact energy:	IK07 2J xx5
Protection class:	I	Optic:	C/EW - Circular Extra-Wide
Beam angle:	2 x 45°	Net weight [kg]:	0.938
Overall diameter [mm]:	224	Overall height [mm]:	74
Cut-out diameter [mm]:	Ø 209	Minimum installation depth [mm]:	80

Mechanical features

Shape:	Round $150 \leq x \leq 300$ mm	Housing material:	Aluminium
Diffuser material:	Opal plastic	Glow wire test [°C]:	650 °C

Electrical features

Voltage type:	AC/DC	Input voltage [V AC]:	220/240
Input frequency [Hz]:	0/50/60	Power factor / COS Φ :	>0.9
Input voltage [V DC]:	176/280	Inrush current [A/ μ s]:	28 / 195
C10 1.5 mm ² :	21	C16 2.5 mm ² :	36
B10 1.5 mm ² :	13	B16 2.5 mm ² :	22

Installation

Application area:	Indoor lighting	Mounting type:	Downlight and spotlight
Min. ambient temperature [°C]:	10	Max. ambient temperature [°C]:	40

Light features

MacAdam:	3	Lumen maintenance:	L80B10@50000h
Distribution of light emission:	Direct		

To maintain the regular updating of our products, PERFORMANCE iN LIGHTING reserves the right to make changes without prior notice. For the most up to date information we always recommend you read the latest version published on the website www.performanceinlighting.com. Delivered luminaire lumen outputs and power consumptions, including losses, are subject to a tolerance of +/- 7%, and unless otherwise stated the values apply to an ambient temperature of 25°C. Terms of warranty are available at <https://www.performanceinlighting.com/qr/company/led-warranty>

Photometric data

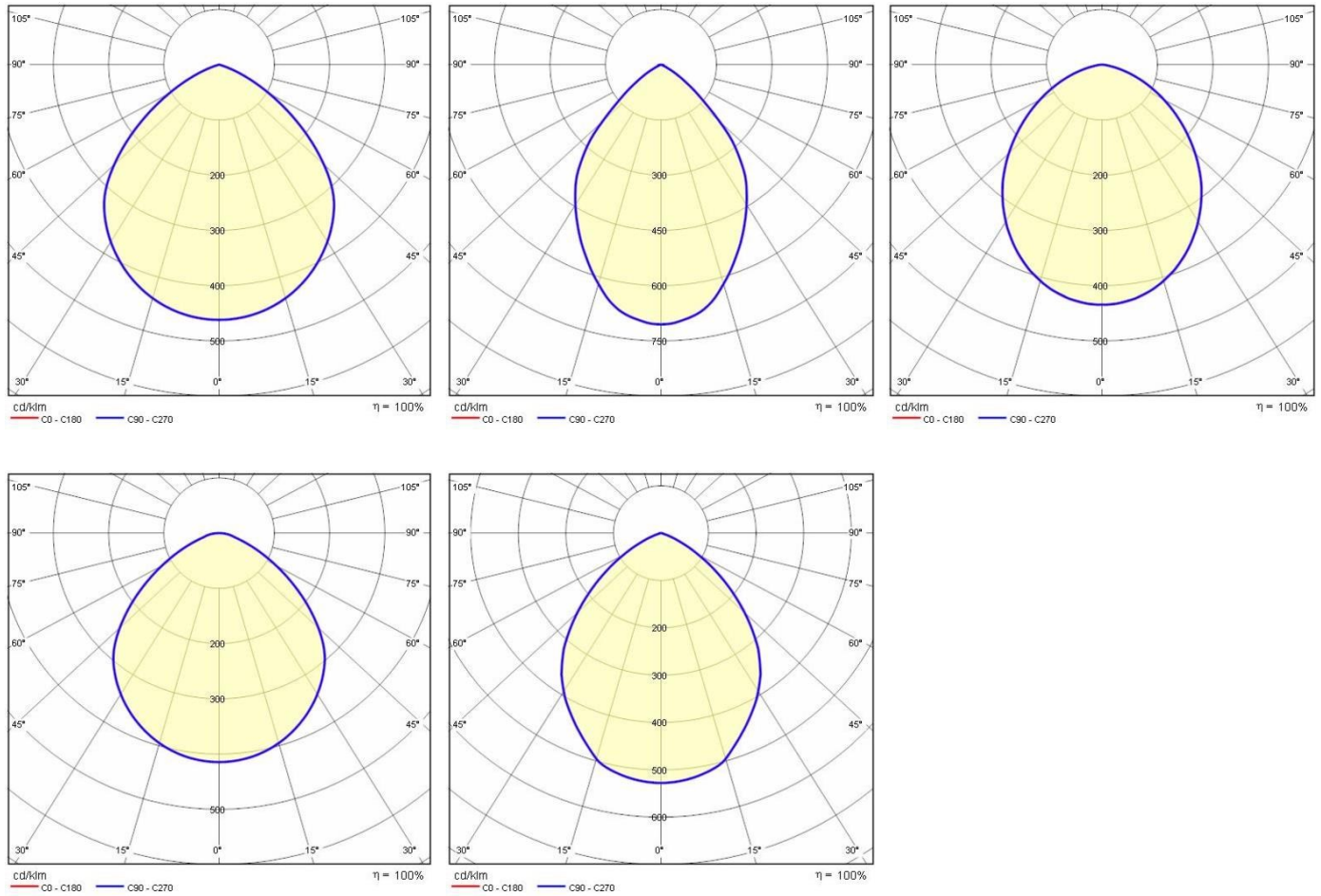

Optional accessories

DL ROUND MAXI



3109010
White reflector DL ROUND MAXI

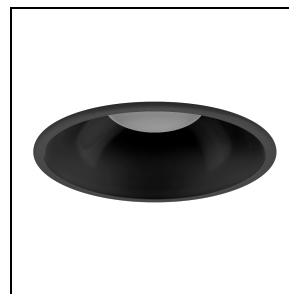

3109011
Black reflector DL ROUND MAXI

To maintain the regular updating of our products, PERFORMANCE IN LIGHTING reserves the right to make changes without prior notice. For the most up to date information we always recommend you read the latest version published on the website www.performanceinlighting.com. Delivered luminaire lumen outputs and power consumptions, including losses, are subject to a tolerance of +/- 7%, and unless otherwise stated the values apply to an ambient temperature of 25°C. Terms of warranty are available at <https://www.performanceinlighting.com/qr/company/led-warranty>



3109012
Louvre reflector DL ROUND MAXI



3109013
Matte plastic panel (IP54) DL ROUND
MAXI

To maintain the regular updating of our products, PERFORMANCE IN LIGHTING reserves the right to make changes without prior notice. For the most up to date information we always recommend you read the latest version published on the website www.performanceinlighting.com. Delivered luminaire lumen outputs and power consumptions, including losses, are subject to a tolerance of +/- 7%, and unless otherwise stated the values apply to an ambient temperature of 25°C. Terms of warranty are available at <https://www.performanceinlighting.com/qr/company/led-warranty>