

DL SQUARE MIDI

Part number 3108988

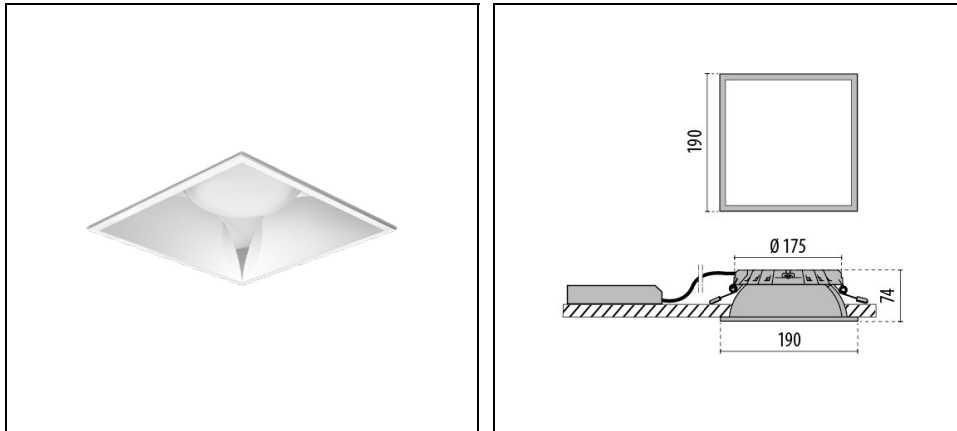

Description

Recessed, modular, LED downlight for indoor, comprising:

- LED module, die-cast aluminium heat sink, reflector with integrated ceiling trim, diffuser and external supply unit
- All components can be tool-less replaced lately
- Integrated diffuser grants an optimised uniformity
- Die-cast aluminium heat sink with Fast™ (Flexible air stream technology) cooling system grants an excellent dissipation and thermal management
- Built-in driver
- Suitable for ceiling tile thickness from 1-25 mm
- Quick and toolless installation

Options:

- High-shine modular radial louvre reflector with integrated ceiling frame made of metallised injection-moulded ABS with light-tight connection to LED module
- Injection-moulded ABS reflector with integral ceiling trim with light-tight connection to LED module and matte plastic pane (IP54)

To maintain the regular updating of our products, PERFORMANCE IN LIGHTING reserves the right to make changes without prior notice. For the most up to date information we always recommend you read the latest version published on the website www.performanceinlighting.com. Delivered luminaire lumen outputs and power consumptions, including losses, are subject to a tolerance of +/- 7%, and unless otherwise stated the values apply to an ambient temperature of 25°C. Terms of warranty are available at <https://www.performanceinlighting.com/qr/company/led-warranty>

Product data

ETIM Group:	EG000027	ETIM Class:	EC001744
-------------	----------	-------------	----------

General information

Lampholder:	LED	Light source:	LED
Lightsource lumen output [lm]:	1900	Luminaire lumen output [lm]:	1640
Luminaire wattage [W]:	13 W	Luminous efficacy [lm/W]:	126
CRI:	90	Colour temperature [K]:	3000
Colour / Finishing:	SL-10 / Silver / Textured	IP degree of protection:	IP20
IP above/below ceiling:	IP20/IP44	Impact resistance / impact energy:	IK07 2J xx5
Protection class:	I	Optic:	C/EW - Circular Extra-Wide
Beam angle:	2 x 36°	Net weight [kg]:	0.705
Overall length [mm]:	190	Overall width [mm]:	190
Overall height [mm]:	74	Cut-out dimensions [mm]:	174 X 174
Minimum installation depth [mm]:	80		

Mechanical features

Shape:	Square 150 ≤ x ≤ 300 mm	Housing material:	Aluminium
Diffuser material:	Opal plastic	Glow wire test [°C]:	650 °C

Electrical features

Voltage type:	AC/DC	Input voltage [V AC]:	220/240
Input frequency [Hz]:	0/50/60	Power factor / COS Φ:	>0.9
Input voltage [V DC]:	176/280	Inrush current [A/μs]:	15 / 204
C10 1.5 mm ² :	41	C16 2.5 mm ² :	66
B10 1.5 mm ² :	25	B16 2.5 mm ² :	40

Installation

Application area:	Indoor lighting	Mounting type:	Downlight and spotlight
Min. ambient temperature [°C]:	10	Max. ambient temperature [°C]:	40

Light features

MacAdam:	3	Lumen maintenance:	L80B10@50000h
Distribution of light emission:	Direct	UGR max.:	20.3

To maintain the regular updating of our products, PERFORMANCE iN LIGHTING reserves the right to make changes without prior notice. For the most up to date information we always recommend you read the latest version published on the website www.performanceinlighting.com. Delivered luminaire lumen outputs and power consumptions, including losses, are subject to a tolerance of +/- 7%, and unless otherwise stated the values apply to an ambient temperature of 25°C. Terms of warranty are available at <https://www.performanceinlighting.com/qr/company/led-warranty>

Photometric data

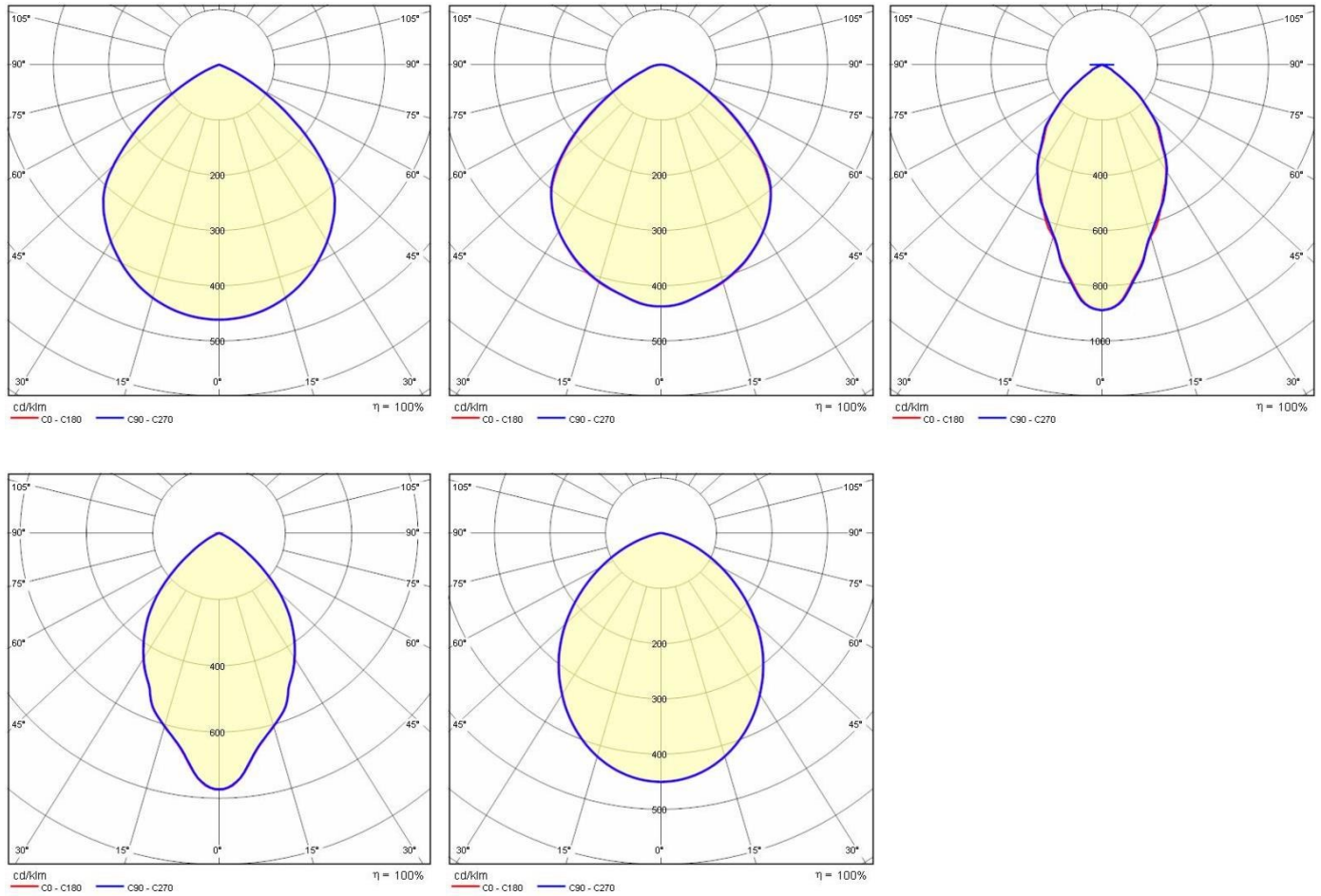

Optional accessories

DL SQUARE MIDI

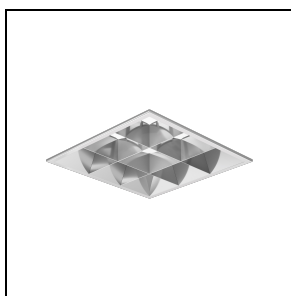

3109016
Louvre reflector DL SQUARE MIDI

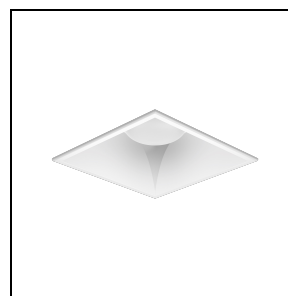

3109014
White reflector DL SQUARE MIDI

To maintain the regular updating of our products, PERFORMANCE IN LIGHTING reserves the right to make changes without prior notice. For the most up to date information we always recommend you read the latest version published on the website www.performanceinlighting.com. Delivered luminaire lumen outputs and power consumptions, including losses, are subject to a tolerance of +/- 7%, and unless otherwise stated the values apply to an ambient temperature of 25°C. Terms of warranty are available at <https://www.performanceinlighting.com/qr/company/led-warranty>



3109017
White optic IP54 DL SQUARE MIDI



3109015
Black reflector DL SQUARE MIDI

To maintain the regular updating of our products, PERFORMANCE IN LIGHTING reserves the right to make changes without prior notice. For the most up to date information we always recommend you read the latest version published on the website www.performanceinlighting.com. Delivered luminaire lumen outputs and power consumptions, including losses, are subject to a tolerance of +/- 7%, and unless otherwise stated the values apply to an ambient temperature of 25°C. Terms of warranty are available at <https://www.performanceinlighting.com/qr/company/led-warranty>