

FL SQUARE 300 RE OP

Part number 8300591233400

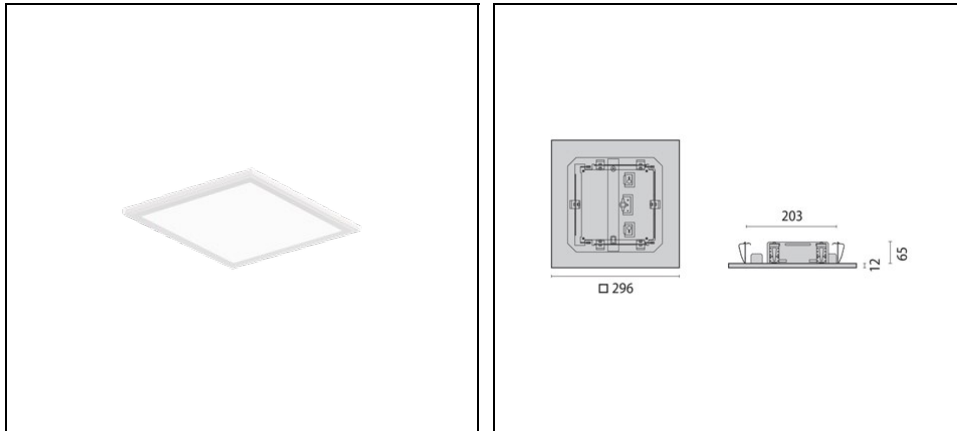

Description

Recessed, square LED luminaire for indoor, comprising:

- Extruded aluminium housing profile, powder-coated
- LED Sidelight-Technology and light orienting plastic optic for a homogenous light distribution over the entire area of the diffuser
- Colour tolerance according to MacAdam ≤ 3 SDCM
- Built-in driver

To maintain the regular updating of our products, PERFORMANCE IN LIGHTING reserves the right to make changes without prior notice. For the most up to date information we always recommend you read the latest version published on the website www.performanceinlighting.com. Delivered luminaire lumen outputs and power consumptions, including losses, are subject to a tolerance of +/- 7%, and unless otherwise stated the values apply to an ambient temperature of 25°C. Terms of warranty are available at <https://www.performanceinlighting.com/qr/company/led-warranty>

Product data

ETIM Group:	EG000027	ETIM Class:	EC002892
-------------	----------	-------------	----------

General information

Lampholder:	LED	Light source:	LED
Lightsource lumen output [lm]:	3000	Luminaire lumen output [lm]:	2260
Luminaire wattage [W]:	19 W	Luminous efficacy [lm/W]:	119
CRI:	80	Colour temperature [K]:	4000
Colour / Finishing:	WH-RAL9016 / White RAL9016 / Textured	IP degree of protection:	IP20
IP above/below ceiling:	IP20/IP43	Impact resistance / impact energy:	IK06 1J xx3
Protection class:	I	Optic:	S/A - Symmetric direct
Beam angle:	2 x 56°	Net weight [kg]:	3.1
Overall length [mm]:	296	Overall width [mm]:	296
Overall height [mm]:	65	Cut-out dimensions [mm]:	203 X 203
Minimum installation depth [mm]:	53		

Mechanical features

Shape:	Square 150 ≤ x ≤ 300 mm	Housing material:	Aluminium
Diffuser material:	Plastic	Glow wire test [°C]:	650 °C

Electrical features

Voltage type:	AC	Input voltage [V AC]:	220/240
Input frequency [Hz]:	220-240V 50/60Hz	Power factor / COS Φ:	0.9
Input voltage [V DC]:	176/280	Inrush current [A/μs]:	25 / 268
C10 1.5 mm ² :	18	C16 2.5 mm ² :	28
B10 1.5 mm ² :	11	B16 2.5 mm ² :	17
EEL:	A2		

Installation

Application area:	Indoor lighting	Mounting type:	Ceiling recessed
Min. ambient temperature [°C]:	10	Max. ambient temperature [°C]:	40

Light features

MacAdam:	3	Lumen maintenance:	L80B10@50000h
Distribution of light emission:	Direct	DFF - Downward Flux Fraction [%]:	100
UFF - Upward Flux Fraction [%]:	0		

To maintain the regular updating of our products, PERFORMANCE IN LIGHTING reserves the right to make changes without prior notice. For the most up to date information we always recommend you read the latest version published on the website www.performanceinlighting.com. Delivered luminaire lumen outputs and power consumptions, including losses, are subject to a tolerance of +/- 7%, and unless otherwise stated the values apply to an ambient temperature of 25°C. Terms of warranty are available at <https://www.performanceinlighting.com/qr/company/led-warranty>

Photometric data

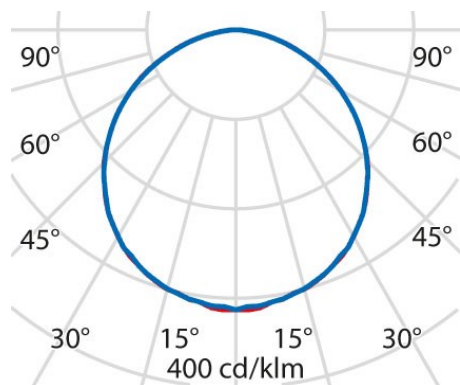

To maintain the regular updating of our products, PERFORMANCE IN LIGHTING reserves the right to make changes without prior notice. For the most up to date information we always recommend you read the latest version published on the website www.performanceinlighting.com. Delivered luminaire lumen outputs and power consumptions, including losses, are subject to a tolerance of +/- 7%, and unless otherwise stated the values apply to an ambient temperature of 25°C. Terms of warranty are available at <https://www.performanceinlighting.com/qr/company/led-warranty>