



MIMIK | WALL MOUNTED | CEILING SURFACE MOUNTED | BOLLARDS

PRODUCT CODE

PROJECT

TYPE

PERFORMANCE
iN LIGHTING

powered by
GEWISS



Company

Performance in Lighting USA, located in Conyers, GA, is part of an international group of companies headquartered in Verona, Italy.

The group was formed from a number of well-established technical lighting companies from various countries. Performance in Lighting has a wide sales and distribution network operating in over 100 countries worldwide. Production facilities are located in Verona Italy, Bergamo Italy, Goslar Germany, Brussels Belgium, Conyers GA USA. Sales/distribution subsidiaries are located in England, Holland, France, Finland, Spain, Portugal, Australia, Dubai and Japan.

Recognized for its unique professional approach and technical know-how, Performance in Lighting has combined its international experience and technical expertise to become a worldwide leader in its industry. The group offers various lighting solutions worldwide for many applications including interior, exterior, residential, commercial, and sports lighting providing options to satisfy both architectural and engineering requirements.

Performance in Lighting USA concentrates on specification grade luminaires designed to provide a vast array of lighting solutions. Our concentration is outdoor products for illuminating commercial spaces from structural facades to parking areas. We strive to meet the demands of today's lighting community offering made in USA products, European designed with clean, contemporary aesthetics along with aggressive price points and fast lead times.

Pronto Program

PERFORMANCE IN LIGHTING offers a wide range of quick ship fixtures through the Pronto Program and a host of options to fit within the unique budget of your next project.





Overview

Click the QR-code for latest information.

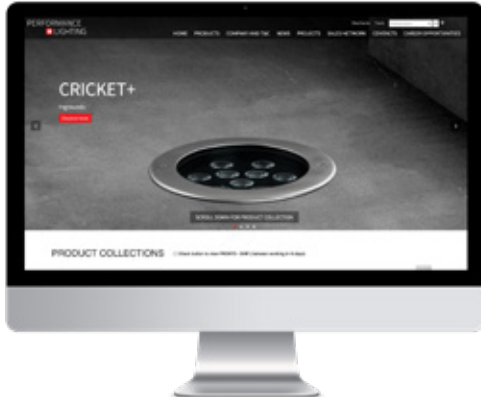

Website

Please visit our web site www.performanceinlighting.com/us/us/ for the latest updated versions available.



5-year warranty

All products are covered by a 5-year warranty, provided that they are used and maintained according to instructions. Focus on quality, safety and product lifetime/longevity are the essential objectives of PERFORMANCE IN LIGHTING. For additional information, email info.usa@pil.lighting

Much more than a pretty face

Unobtrusive and elegant, like chameleons, these units perfectly blend with the interior of the architectural space, creating an effect of luminous mimicry.

Ultra-flat luminaires conceived entirely around low energy consumption using the latest generation LED sources. The MIMIK is suitable for all applications requiring a wall mount luminaire. Its minimal design and reduced thickness of less than 2-inches allow for discreet integration in all indoor and outdoor architectural contexts.

The MIMIK series of fixtures is an exclusive PERFORMANCE IN LIGHTING design and the only like it in the industry. The MIMIK accessory faceplate allows designers the ability to clad the installation in any material they choose, allowing creativity to flourish.

Contemporary styling makes the bollards for the MIMIK 10 and 20 a timeless addition to both residential and commercial projects. The MIMIK 10 bollard, available in three standard heights, provides much more than a bollard; it gives you cohesiveness. We offer two bollard choices for the MIMIK 20 bollard, which includes a signage option.

The new MIMIK 50 is a large-sized, high-performance wall pack for any perimeter lighting that is also suitable for the urban context. The essential lines allow total integration in any contemporary setting, and it can be combined with the rest of the family.

The MIMIK series, available in ceiling mount (MIMIK 10 / 20), wall effect (MIMIK 10), wall sconce (MIMIK 20 / 30), wall pack (MIMIK 50), bollard (MIMIK 10 / 20), and FLAT options, provides much more than fittings. It gives you total design cohesiveness.

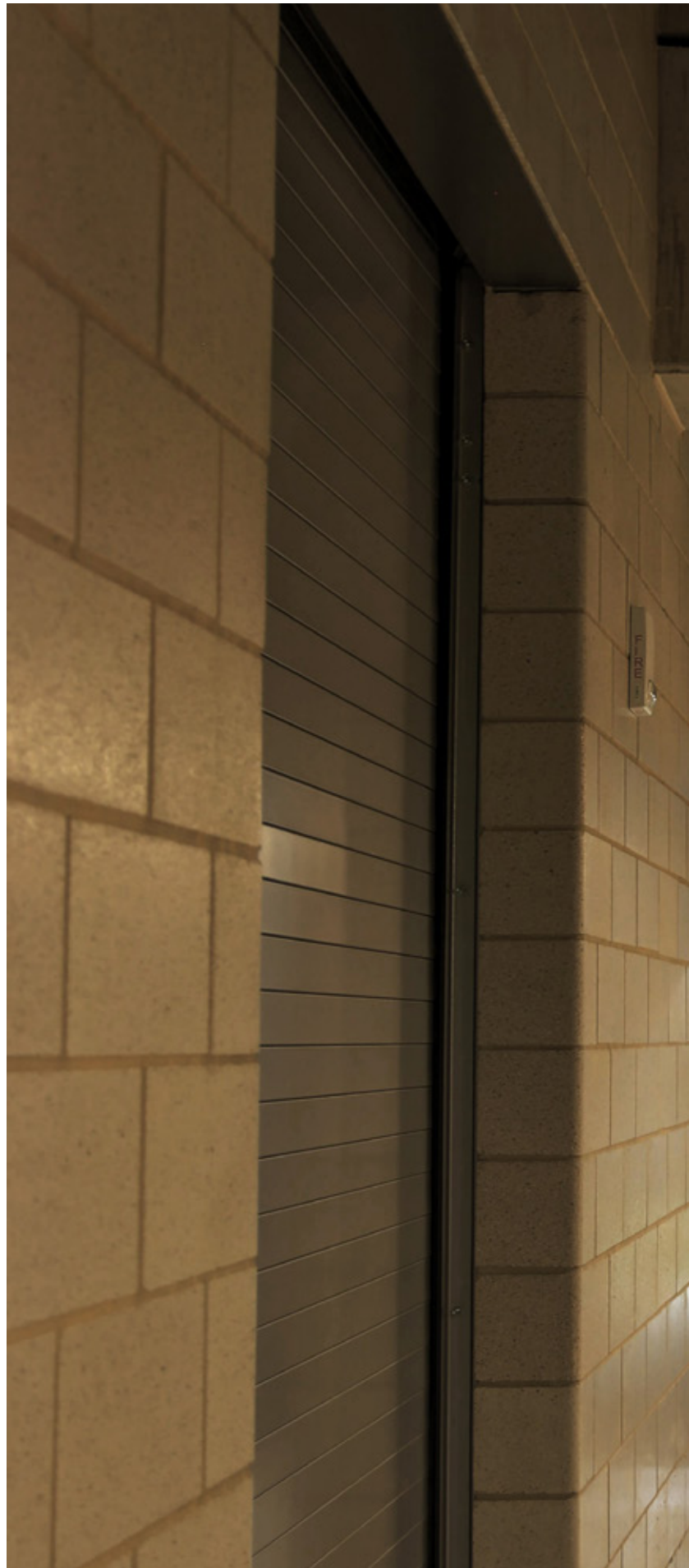



Suntrustpark Braves stadium | Atlanta | Georgia | USA

Design-coordinated ceiling mount (MIMIK 10 / 20 CEILING), wall sconce (MIMIK FLAT), wall effect (MIMIK 10), wall packs (MIMIK 20 / 30 / 50), post mount (MIMIK 20) and bollard (MIMIK 10) series. Fixtures consist of:

Construction

- Multi-step powder-coat painting process, optimized against UV rays and corrosion.
- Copper-free precision die-cast aluminum housing, mounting plate (MIMIK 10 / 20 / 30 / 50), faceplate (MIMIK 10 / 20 CEILING) and copper-free aluminum extruded post (MIMIK 10 POST and MIMIK 20 bollards).
- Micro-prismatic patterned flat, tempered silk-screened soda-lime glass diffuser (MIMIK FLATs / 10 CEILING TECH / 20 CEILING). High-transmittance transparent optics. Extra-clear, flat, tempered silk screened soda-lime glass diffuser (MIMIK 10 / 20 / 30 / 50, MIMIK 10 CEILING / POST).
- Custom MCPCB utilized to maximize heat dissipation and promote long LED life.
- Custom molded, anti-aging gasket(s).
- Stainless steel external hardware.

Installation

- Available in four standard sizes of H5" x L5" (MIMIK 10), H8" x L8" (MIMIK 20), H5" x L12" (MIMIK 30) and H20" x L20" (MIMIK 50). Overall standard depths of 1.65" (FLAT), 2.56", and 3.6". MIMIK 20 and MIMIK 20 FLAT are available for post mount on bollard or LINE bollard. MIMIK 10 BOLLARD is available in three standard heights of 11.81" (300), 23.62" (600), and 39.37" (1000).
- Customizing facade faceplate available for various versions (ordered separately).
- Pre-wired factory sealed cable for external electrical connection included.
- Steel ground base plate included for bollards.

Optics

- Circular Intensive (C/I), and Symmetric Extra-Wide (TECH - S/EW) optics for ceiling versions. Type II (MIMIK 20 / 30 / 50), Type III (MIMIK 10 / 20 / 30 / 50), Type IV (MIMIK 20 / 30 / 50), and Circular Intensive (MIMIK 10 C/I) optics and light distributions with single (M) and dual light emission (B).

Electrical

- Input voltage: 120-277 V (50 / 60 Hz), integral 0-10 V dimming driver (MIMIK 20 / 30 / 50).
- Input voltage: 120-277V (50 / 60 Hz), integral driver (MIMIK 10).
- Optional, integral, emergency battery-pack designed for a minimum operation of 90 minutes (EMPK versions).
- Optional, integral, line-voltage, passive infrared motion sensor (PIR SENSOR versions).

Options

- The luminaire may be configured with numerous options and multiple standard finishes. Not all options are available in all configurations. Consult factory for more information about specification sheet details to build your light.

Listings

- UL Wet location listed. IP65 rated.
- Product meets Buy American Act (BAA) requirements within ARRA.
- ADA compliant.
- Consult factory for which version qualifies for the PRONTO-SHIP program. Orders must be marked "PRONTO."
- Photometric data measured according to UNI EN 13032-1/4 and IES LM-79-08
- The light distribution complies with the IESNA Full Cut-Off Classification and is eligible for all "Dark Sky" applications when aimed down.
- Actual performance may differ as a result of the end-user environment and application. All values are design or typical values, measured under laboratory conditions at 25 °C. Specifications are subject to change without notice.

Warranty

- 5-year limited warranty. Complete warranty terms located at www.performanceinlighting.com



MIMIK 10 CEILING



MIMIK 20 CEILING



MIMIK 50



MIMIK 10



MIMIK 20



MIMIK 30



MIMIK 10 FLAT



MIMIK 20 FLAT



MIMIK 30 FLAT



MIMIK 10 BOLLARD 300



MIMIK 10 BOLLARD 600



MIMIK 10 BOLLARD 1000

MIMIK 10 / 20 CEILING



Copper-free precision die-cast aluminum housing.

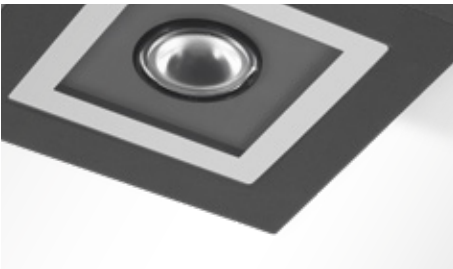

Extra-clear, flat, tempered silk screened soda-lime glass diffuser (MIMIK 10 CEILING).

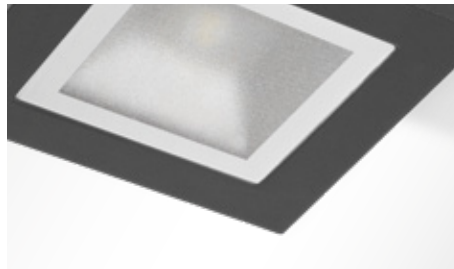

Micro-prismatic patterned, flat, tempered silk screened soda-lime glass diffuser (MIMIK 10 CEILING TECH).



High-transmittance transparent optics.

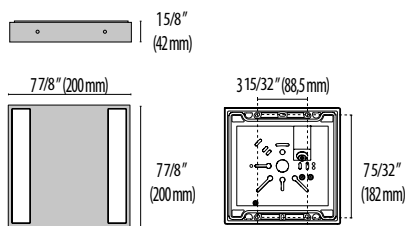
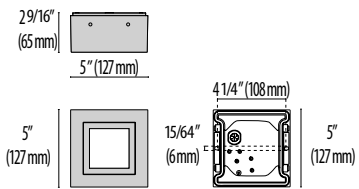

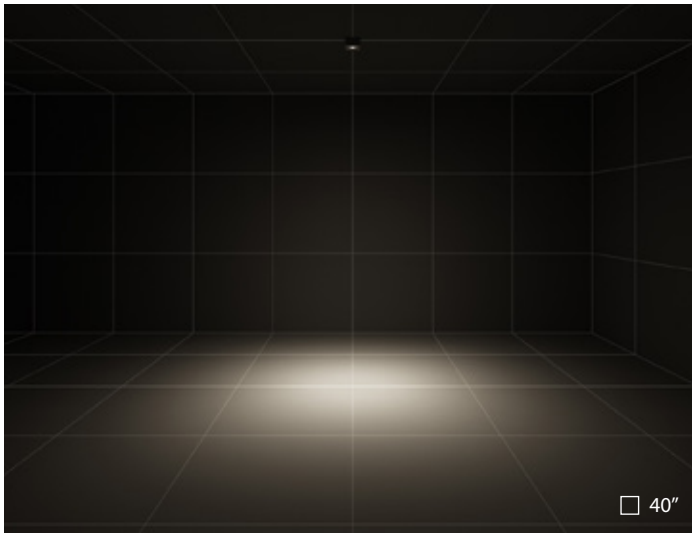

MIMIK 10 CEILING | C/I 20° Circular Intensive optics

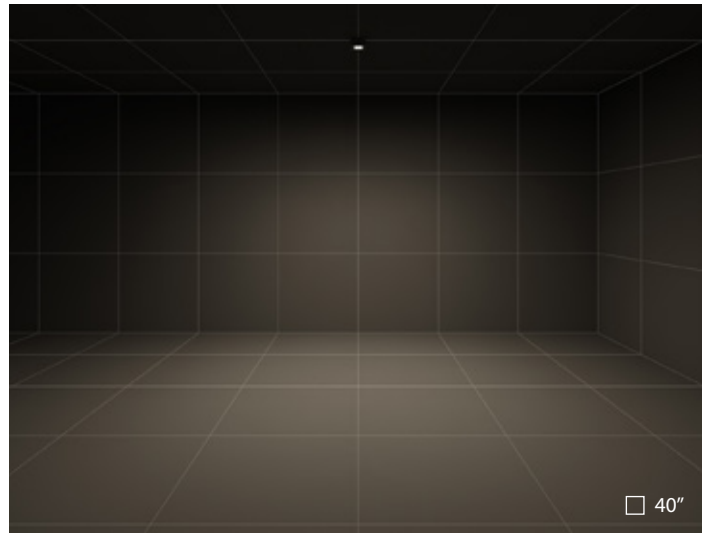

MIMIK 10 CEILING TECH | C/W 100°

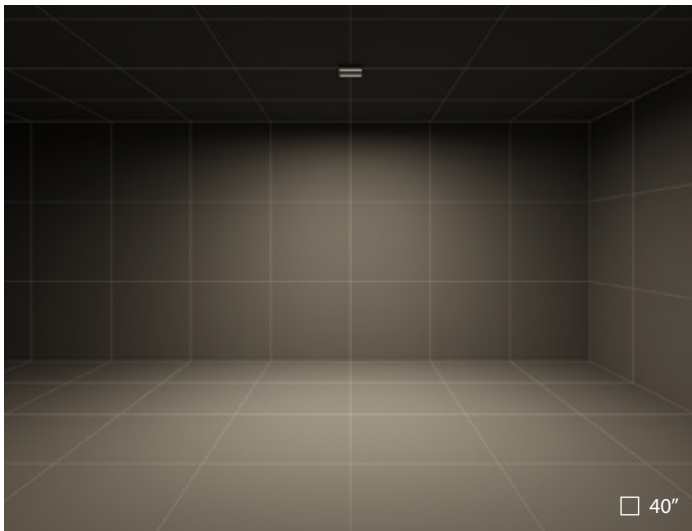

MIMIK 20 CEILING | S/EW Symmetric Extra-Wide optics

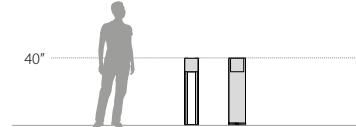

Customizing facade faceplate cover available for MIMIK 10 / 20 / 30 (to be ordered separately).
Optional, integral, emergency battery-pack designed for a minimum operation of 90 minutes (EMPK versions). Available for MIMIK 20 only.



Polyester powder coated die-cast aluminum housing.



High-transmittance transparent optics. Extra-clear, flat, tempered silk screened soda-lime glass diffuser.



Clear Plexiglas, customized with signs or logo.



Post accessory available for MIMIK 20 (ordered separately)



Post accessory available for MIMIK 20 (ordered separately)

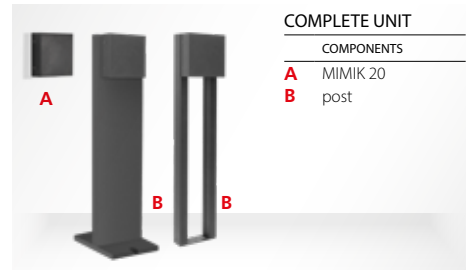

For products that must be mounted on a post, bracket, track or recessed into the wall, it is often necessary to order several different parts (codes) to get the complete configuration.

COMPLETE UNIT	
COMPONENTS	
A	MIMIK 20
B	post

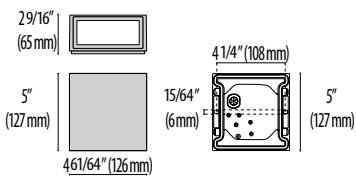

MIMIK 10

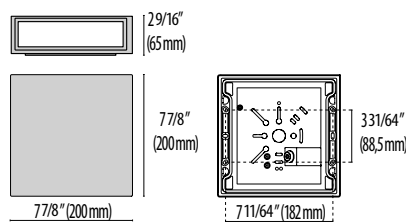

MIMIK 20

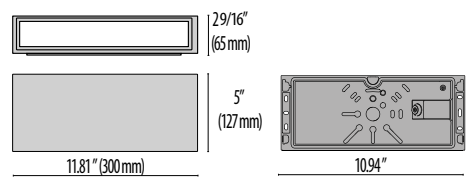

MIMIK 30

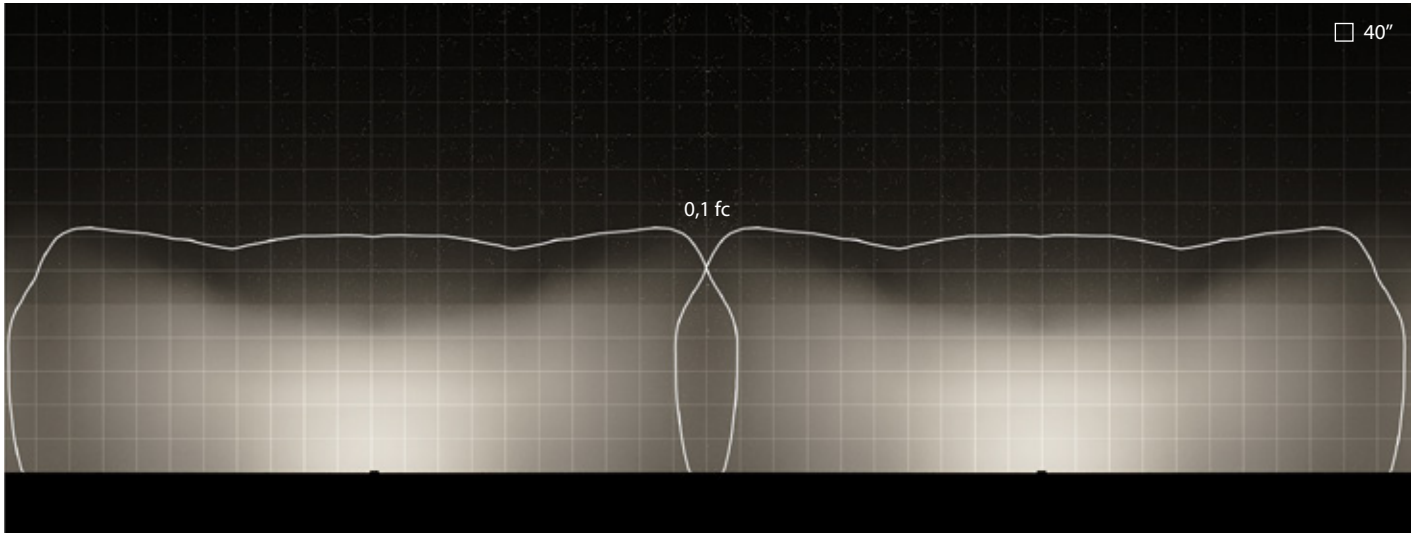

MIMIK 30 | TYPE III

Luminaire spacing = 65' 7" (20m)
 Path depth = 16' 5" (5m)
 Mounting height = 9' 10" (3m)

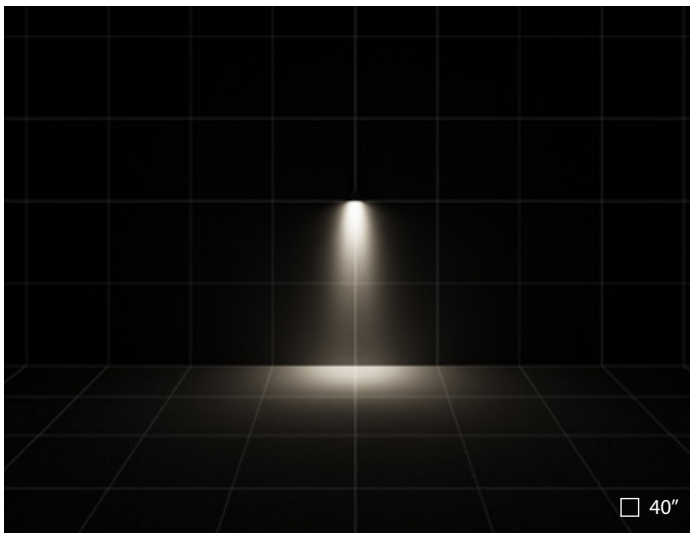

MIMIK 10 M | C/I 20° Circular Intensive optics

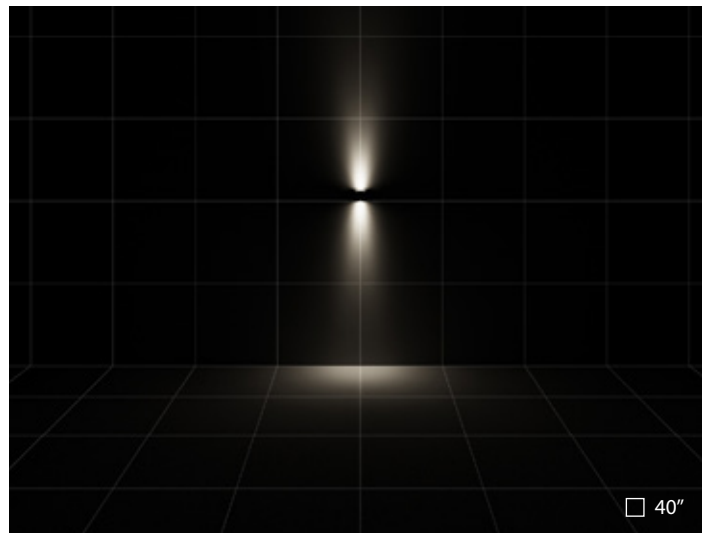

MIMIK 10 B | C/I 20° Circular Intensive optics

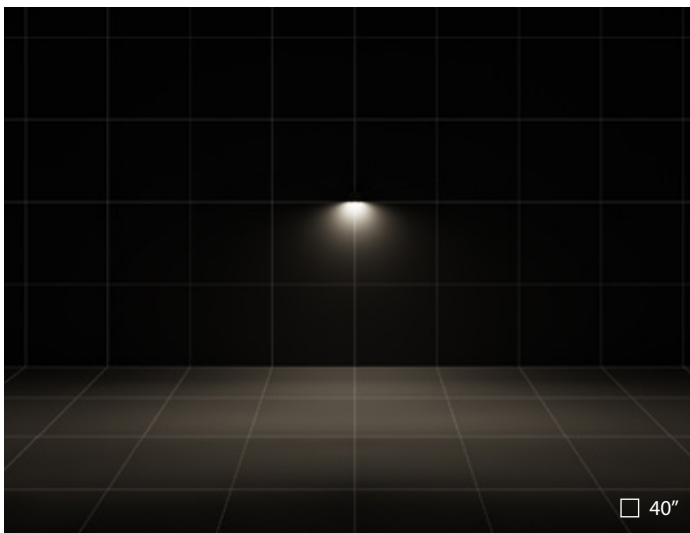

MIMIK 10 M | TYPE III

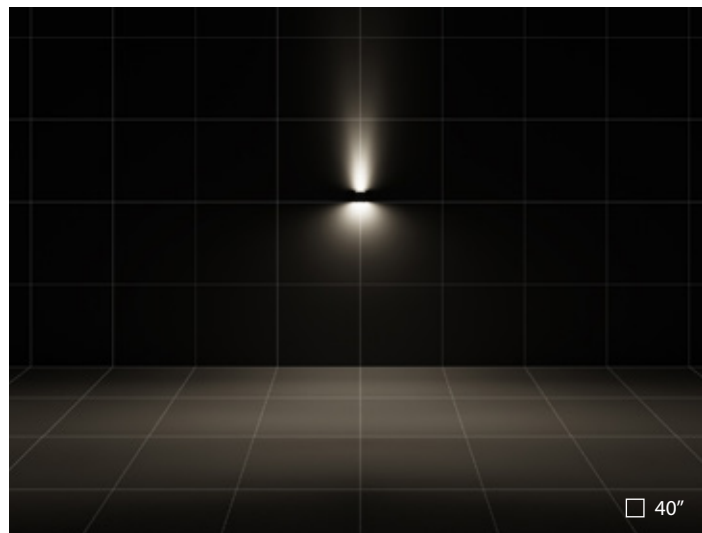

MIMIK 10 B | C/I 20° Circular Intensive optics + TYPE III

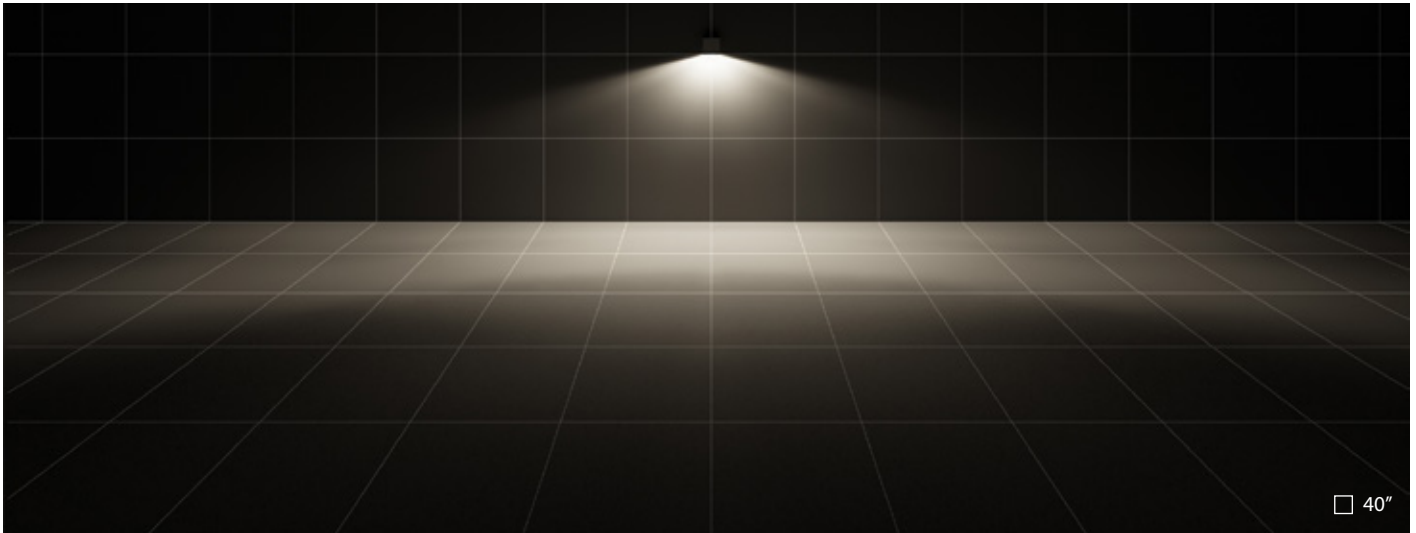

MIMIK 20 | TYPE II

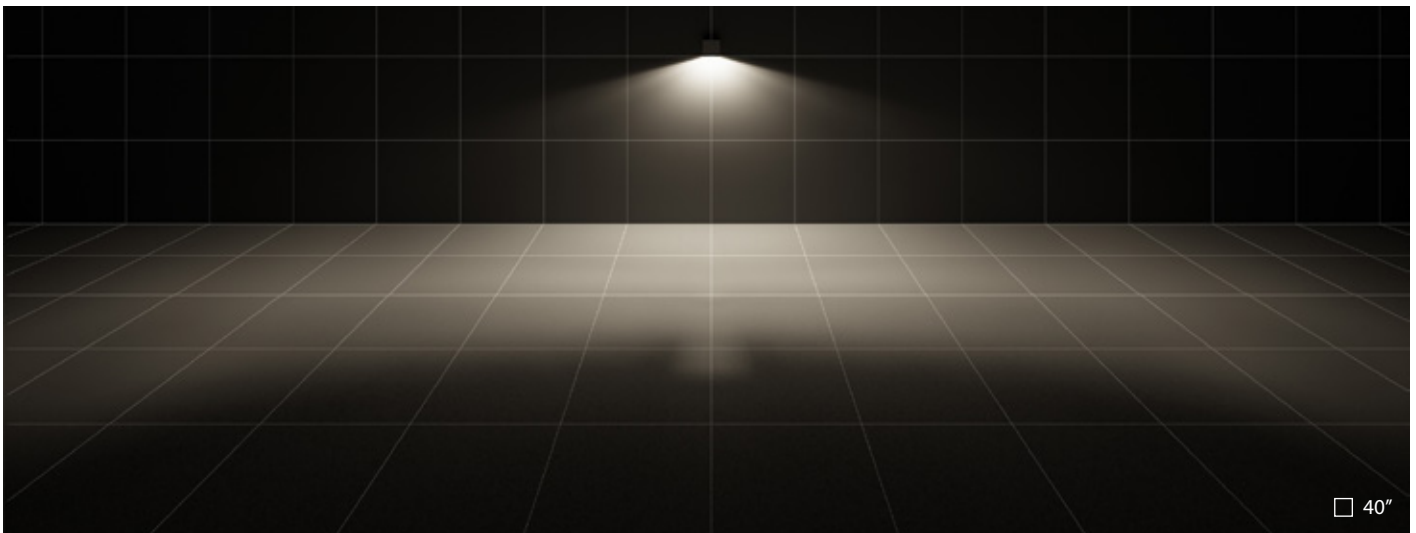

MIMIK 20 | TYPE III

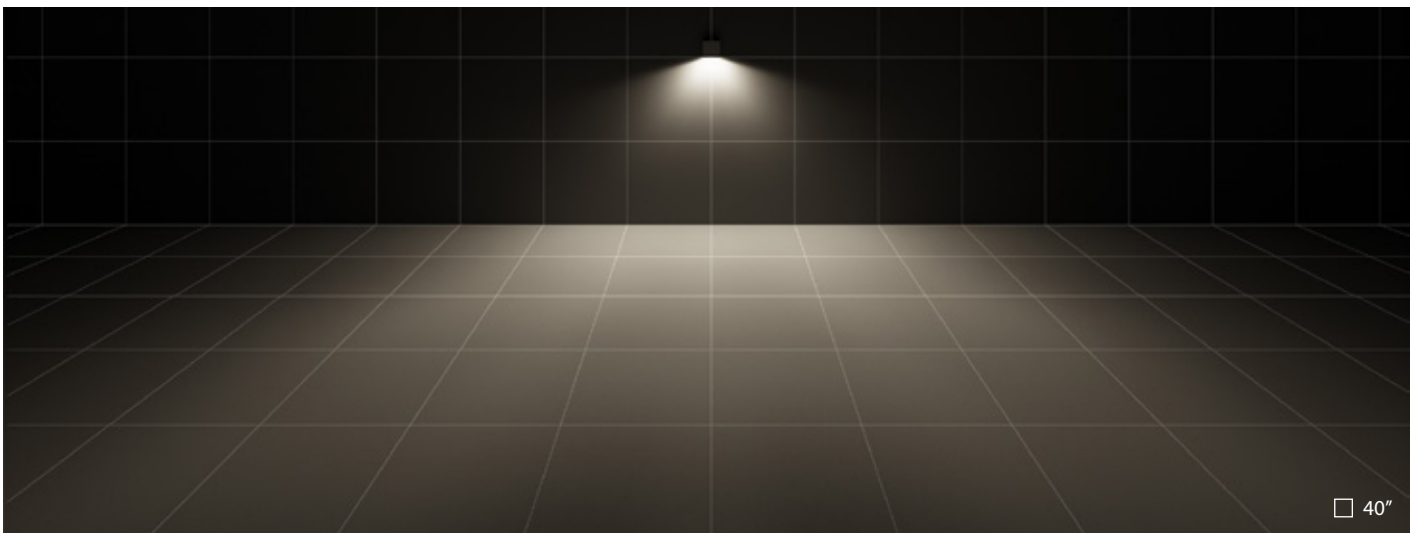

MIMIK 20 | TYPE IV

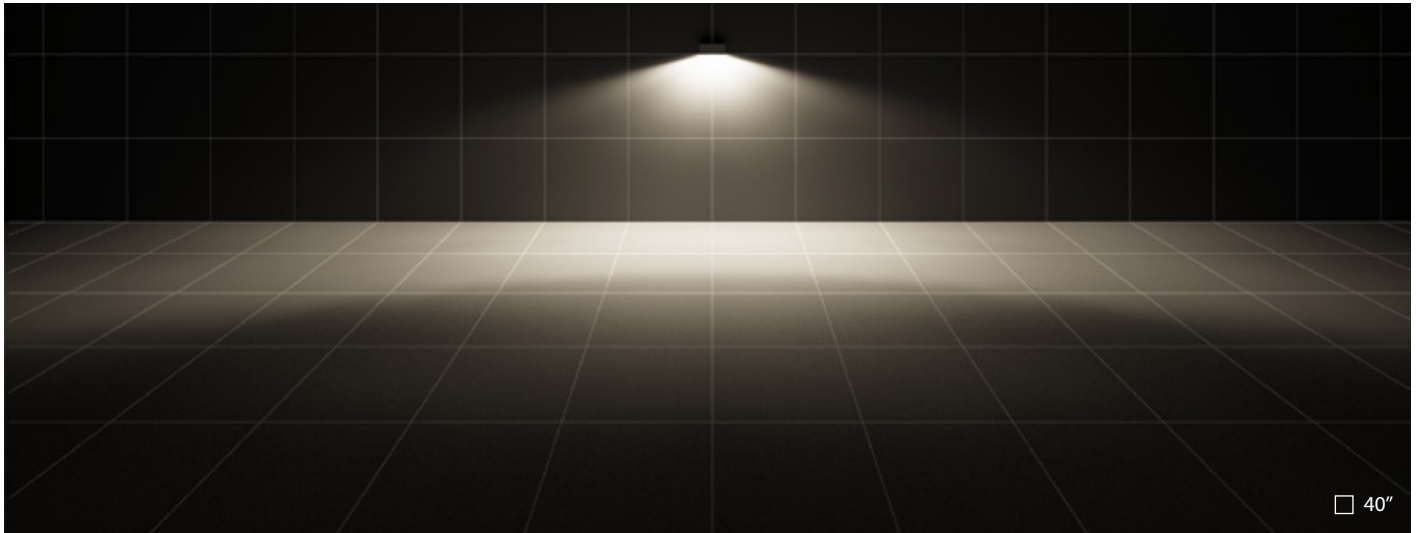

MIMIK 30 | TYPE II

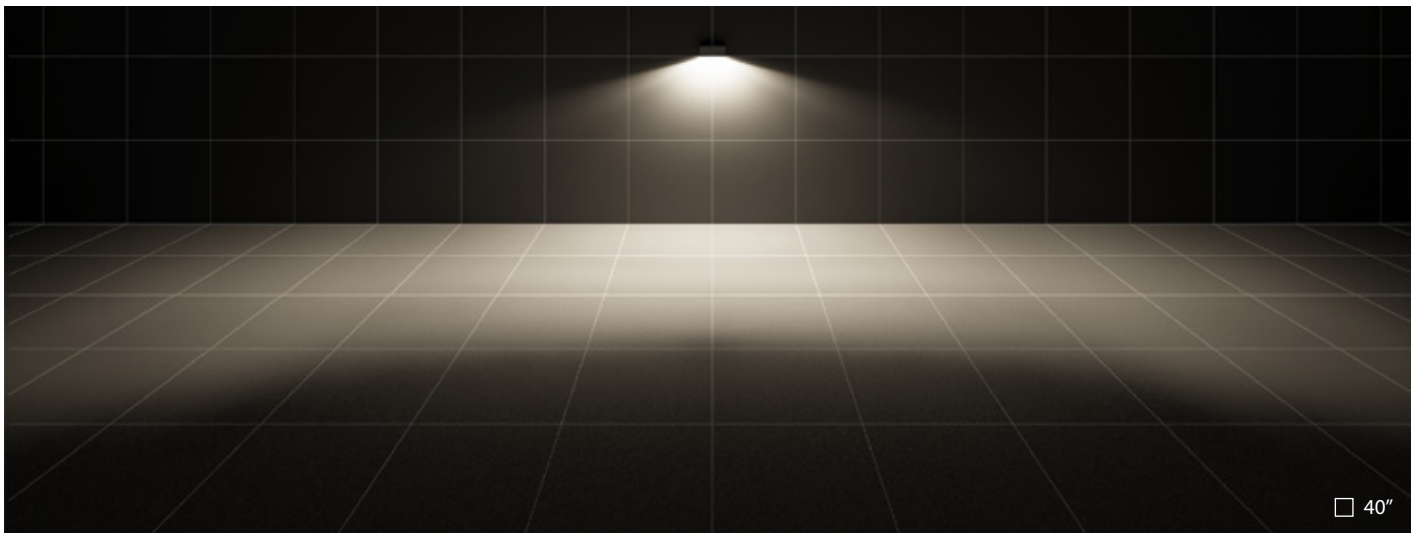

MIMIK 30 | TYPE III

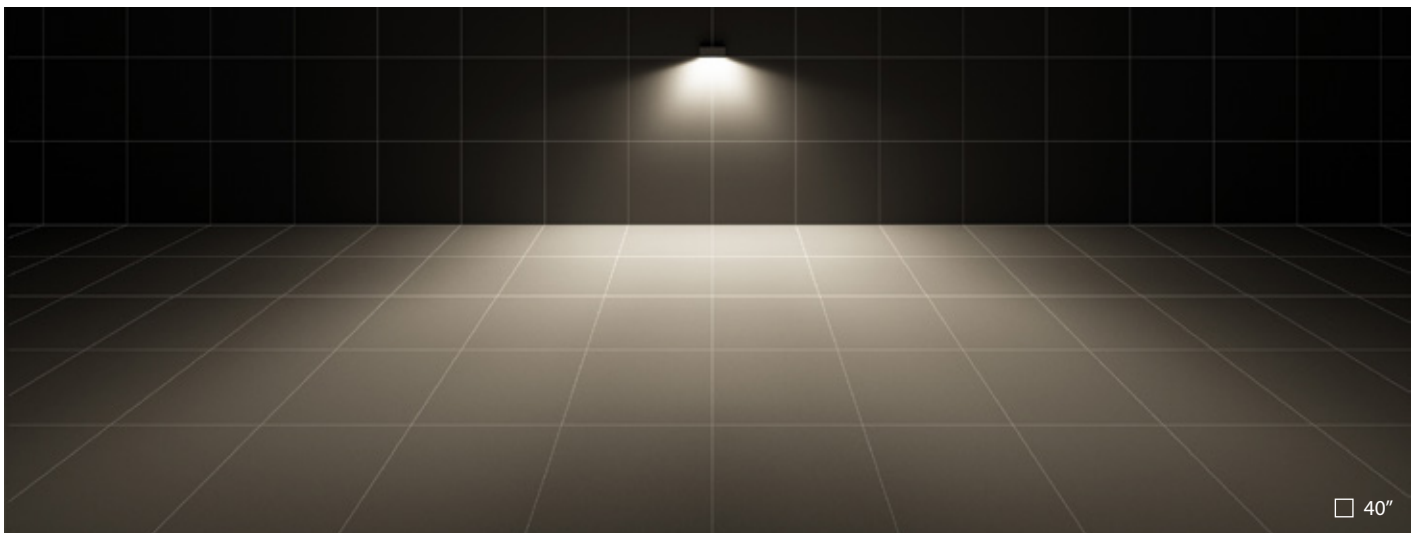

MIMIK 30 | TYPE IV

MIMIK 10 / 20 / 30 FLAT

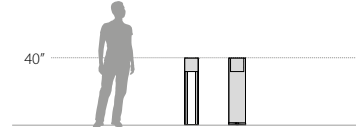

Customizing facade faceplate cover available for MIMIK 10 / 20 / 30 (to be ordered separately).



Polyester powder coated die-cast aluminum housing.



Micro-prismatic patterned, flat, tempered silk screened soda-lime glass diffuser.



Clear Plexiglas, customized with signs or logo.

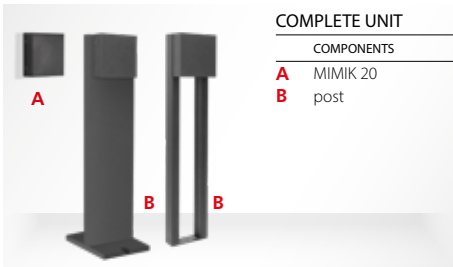

For products that must be mounted on a post, bracket, track or recessed into the wall, it is often necessary to order several different parts (codes) to get the complete configuration.

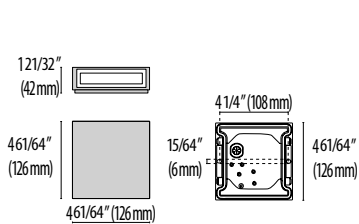

MIMIK 10 FLAT

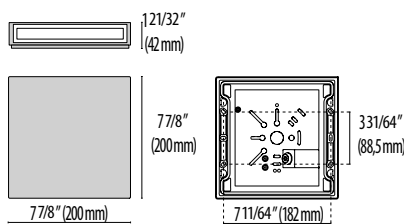

MIMIK 20 FLAT

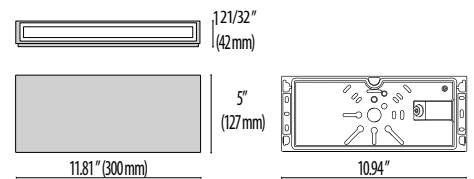

MIMIK 30 FLAT

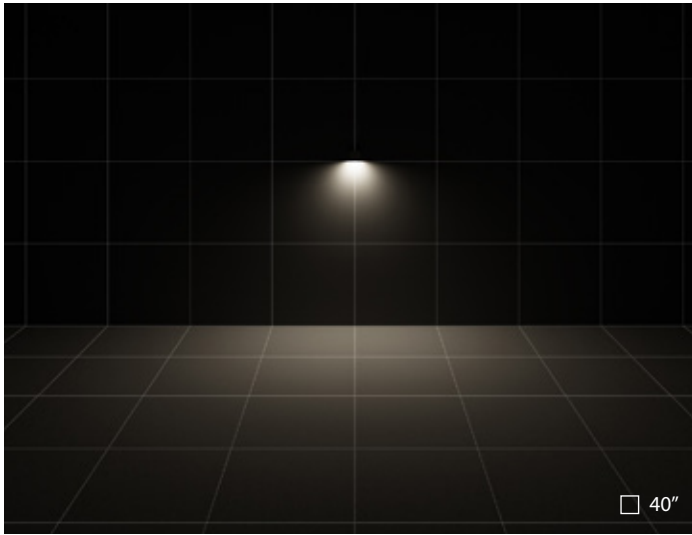

MIMIK 10 FLAT M | TYPE III

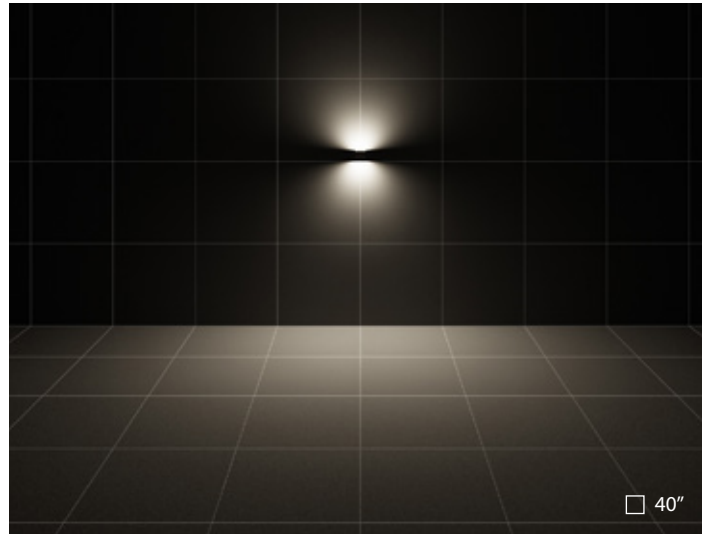

MIMIK 10 FLAT B | TYPE III

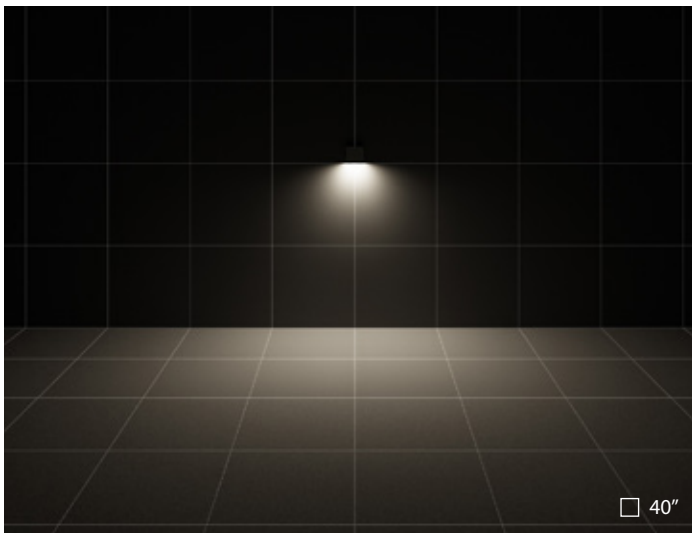

MIMIK 20 FLAT M | TYPE II

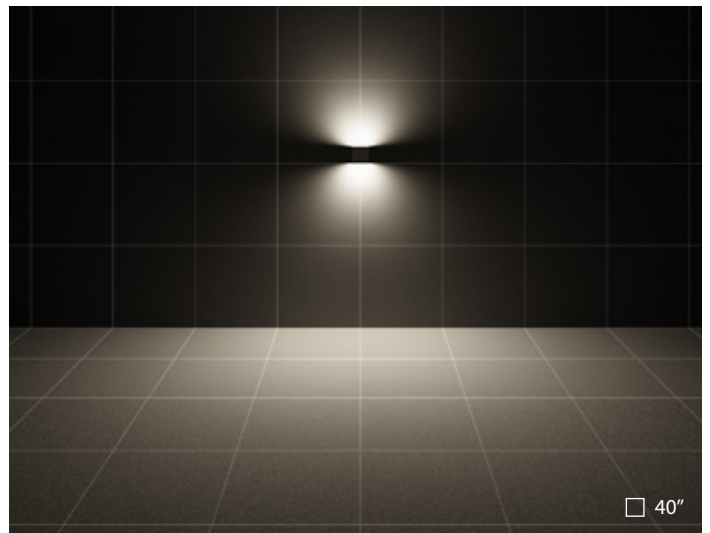

MIMIK 20 FLAT B | TYPE II

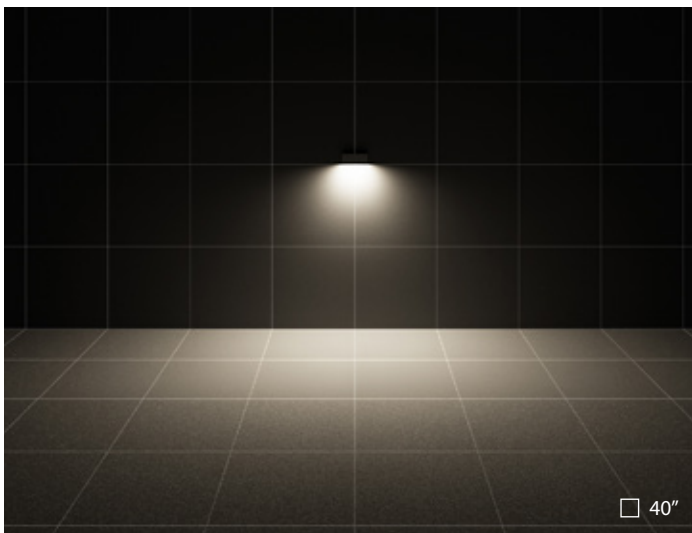

MIMIK 30 FLAT M | TYPE II

MIMIK 50



High-transparency polycarbonate lenses for best light transmission.



Extra-clear flat tempered glass diffuser internally screen-printed.



The fitting is suitable for through-wiring.

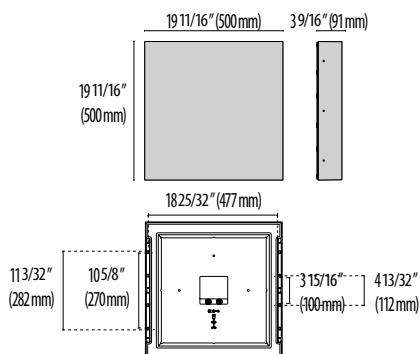

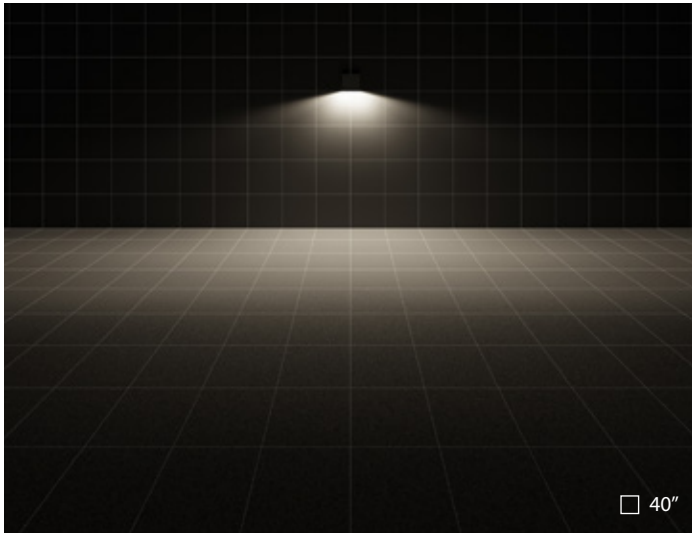

MIMIK 50 M | TYPE II

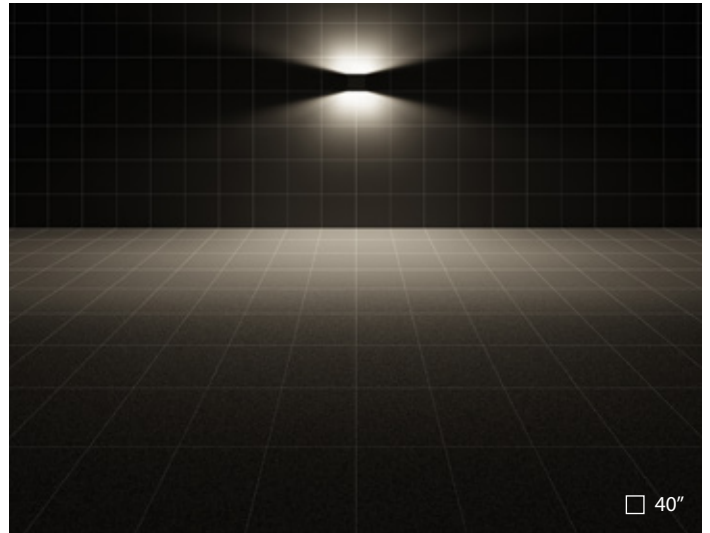

MIMIK 50 B | TYPE II

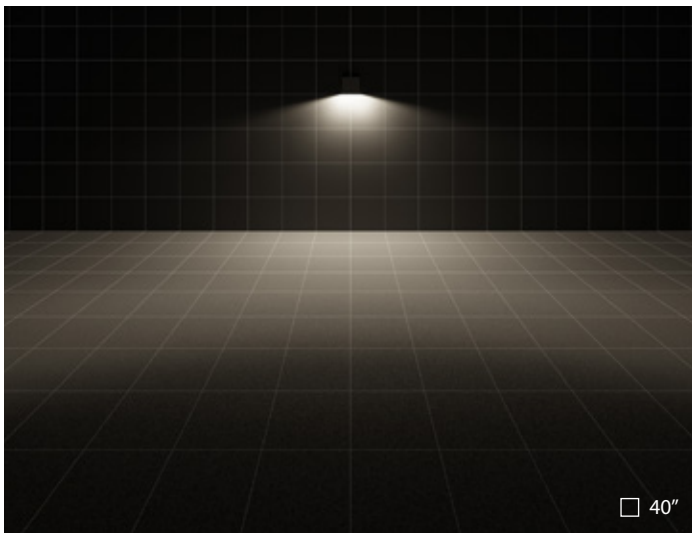

MIMIK 50 M | TYPE III

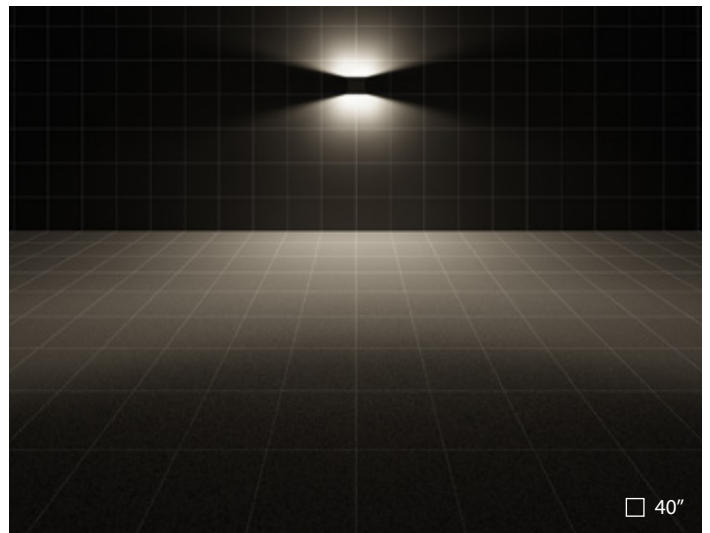

MIMIK 50 B | TYPE III

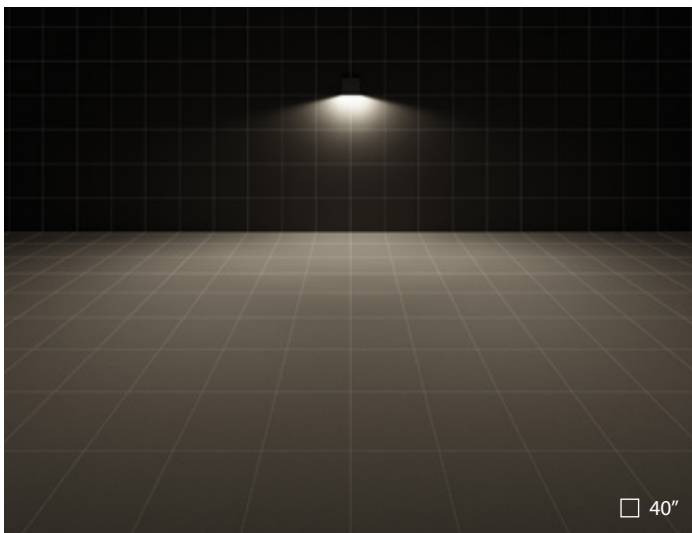

MIMIK 50 M | TYPE IV

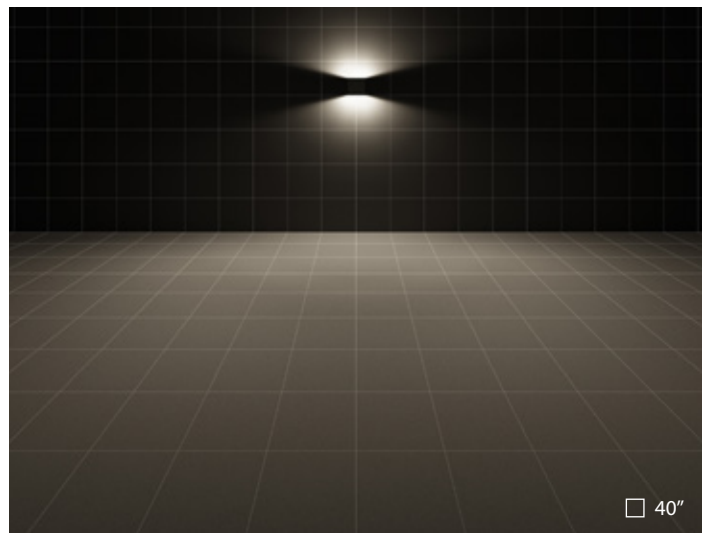

MIMIK 50 B | TYPE IV

MIMIK 10 BOLLARD 300 / 600 / 1000

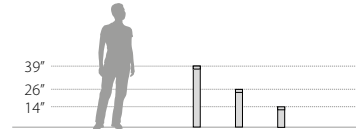

The light distribution complies with the IESNA Full Cut-Off Classification and is eligible for all "Dark Sky" applications.



Tempered glass diffuser, printed.



Version is available with line voltage passive infrared fixture integrated motion sensor (Wattstopper).



Optional surface mounted GFCI receptacle. Consult factory for more information.

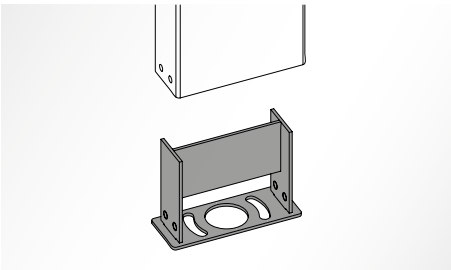

Steel ground base plate included. Anchors are to be ordered separately or are by others.

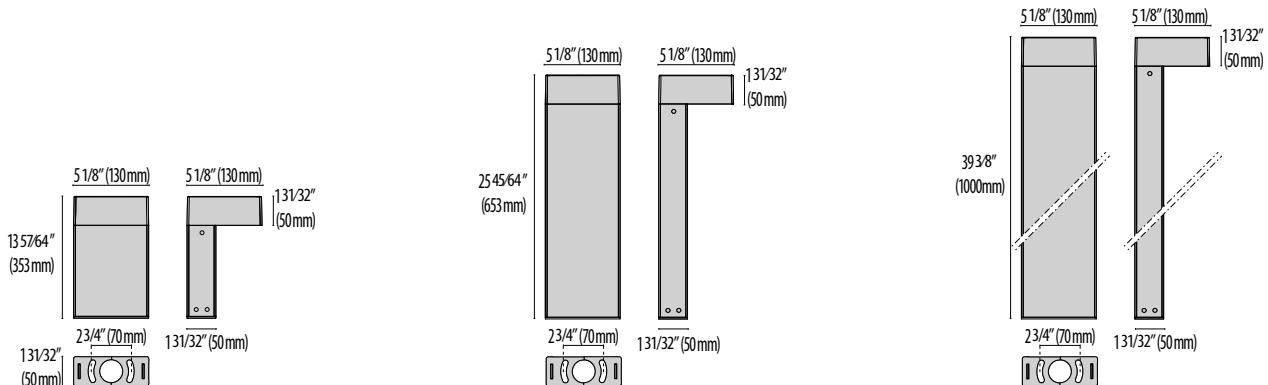

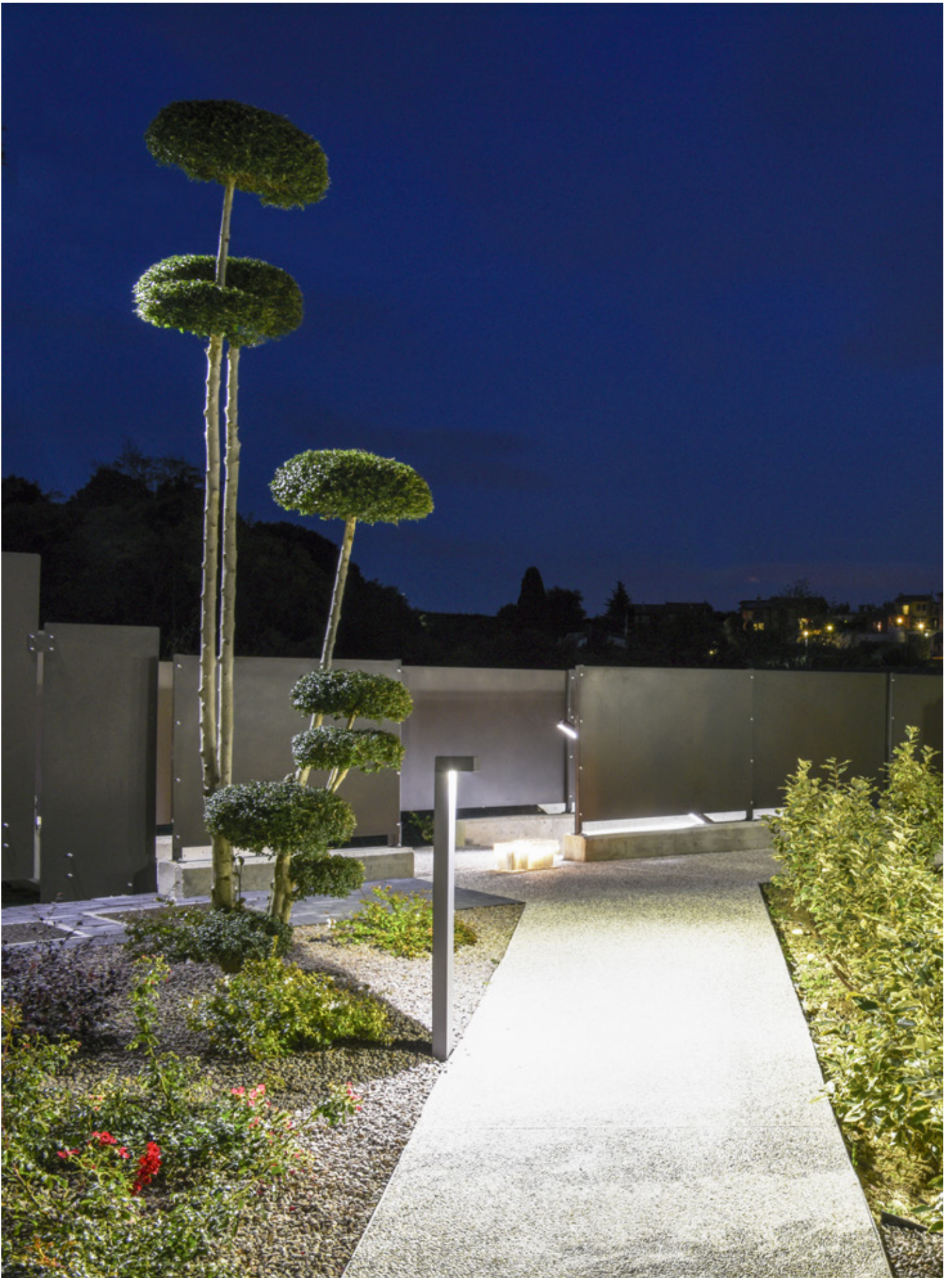

Residence "La Valle" | Verona | ITALY

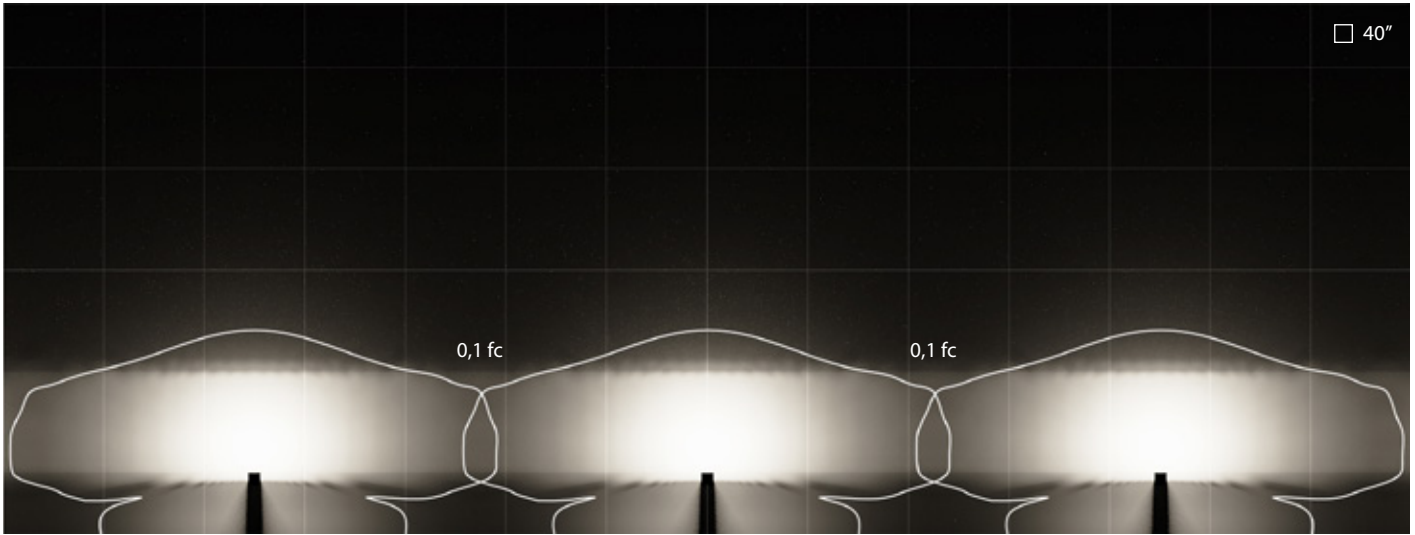

MIMIK 10 BOLLARD 600 | TYPE II | linear

Luminaire spacing = 14' 9" (4.5m)
 Path depth = 3' 3" (1m)
 Mounting height = 0m

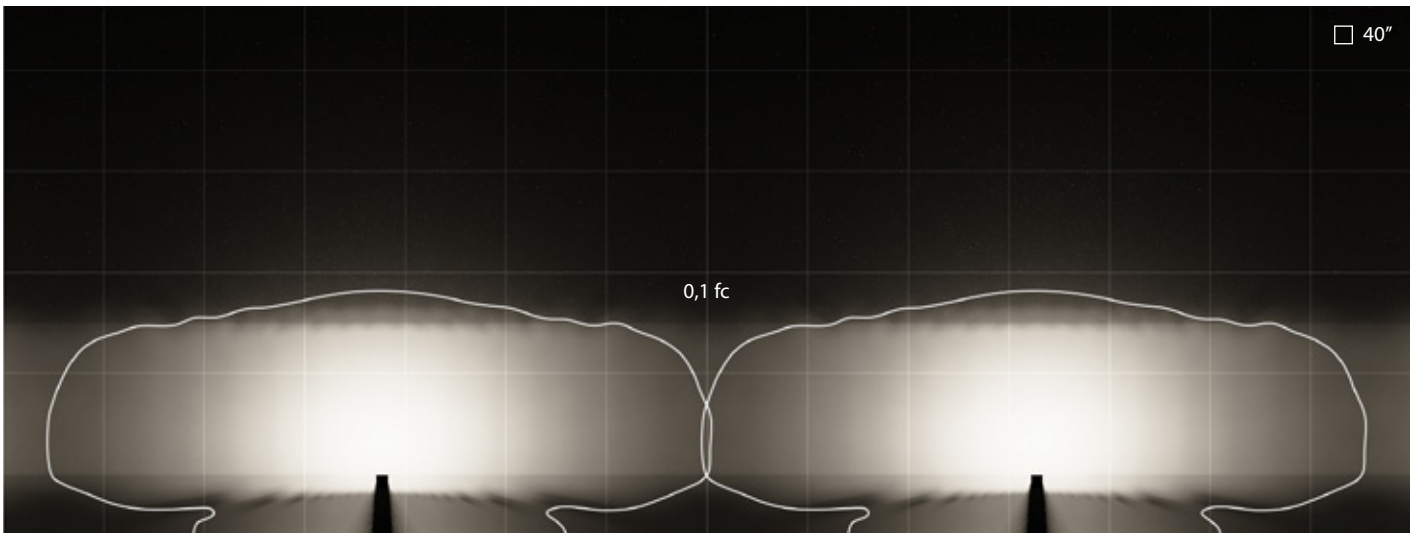

MIMIK 10 BOLLARD 1000 | TYPE II | linear

Luminaire spacing = 21' 4" (6.5m)
 Path depth = 4' 11" (1.5m)
 Mounting height = 0" (0m)

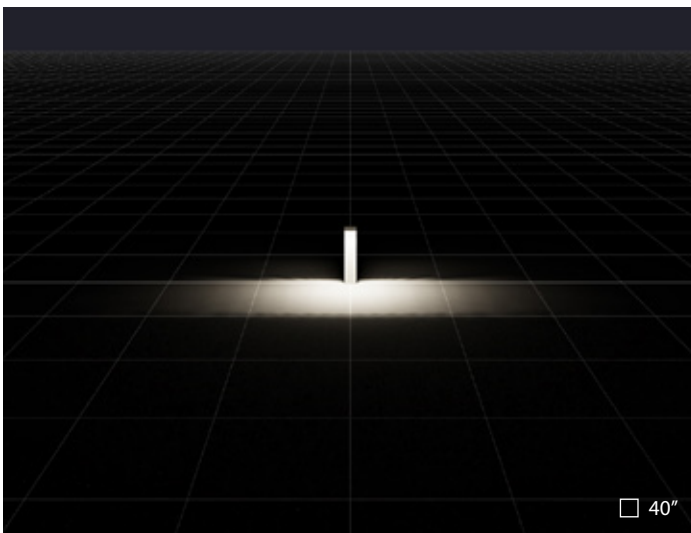

MIMIK 10 BOLLARD 600 | TYPE II

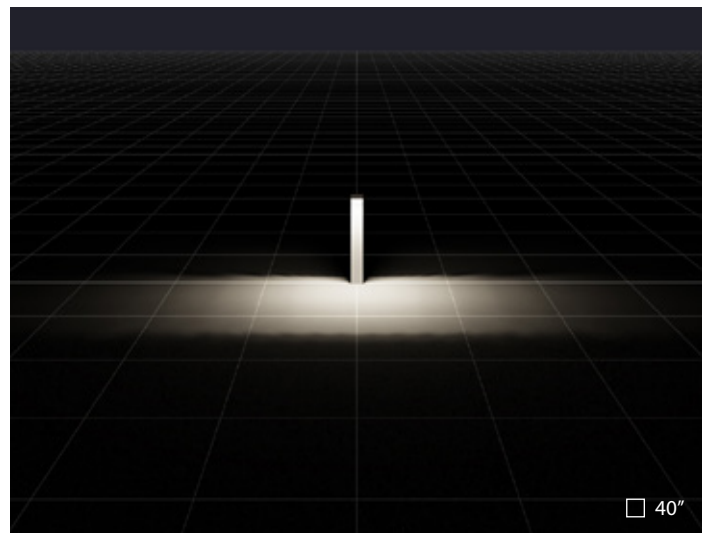

MIMIK 10 BOLLARD 1000 | TYPE II

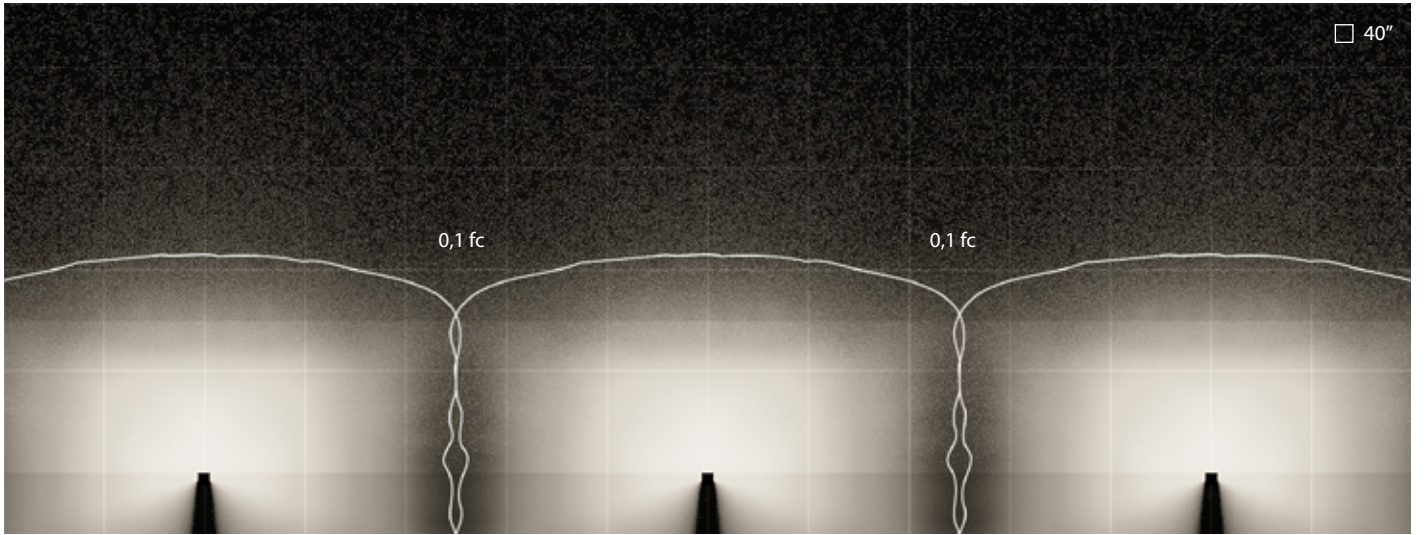

MIMIK 10 BOLLARD 600 | TYPE III | linear

Luminaire spacing = 16' 5" (5m)
 Path depth = 4' 11" + 3' 3" (1.5m + 1m)
 Mounting height = 0m

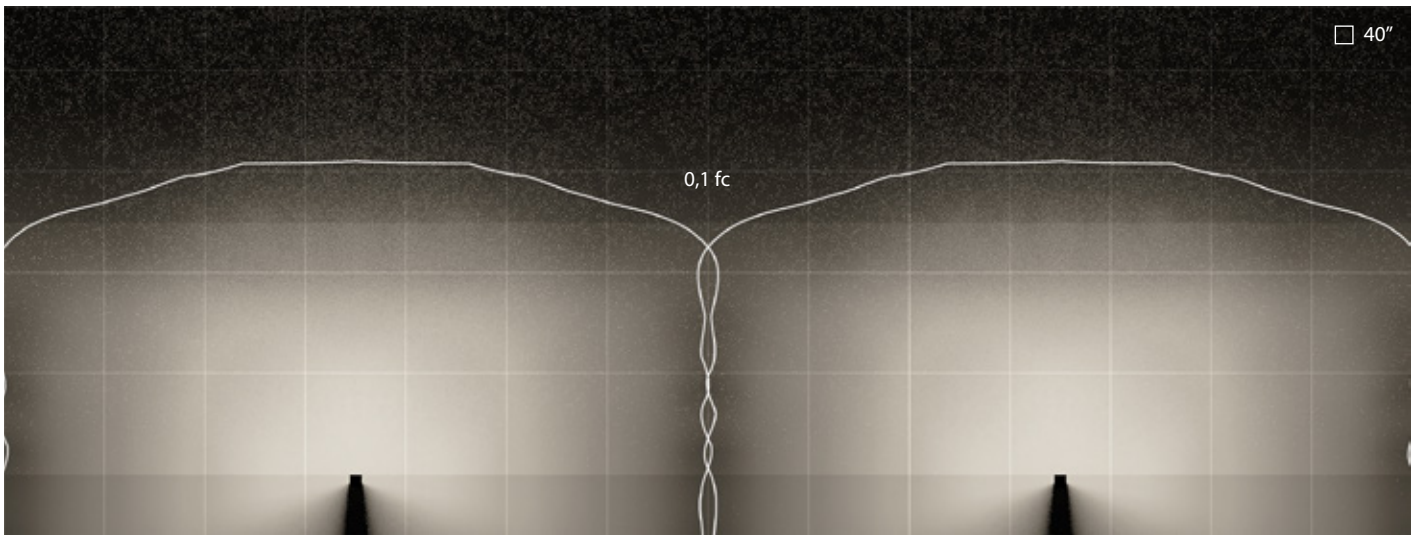

MIMIK 10 BOLLARD 1000 | TYPE III | linear

Luminaire spacing = 23' 0" (7m)
 Path depth = 8' 2" + 4' 11" (2.5m + 1.5m)
 Mounting height = 0" (0m)

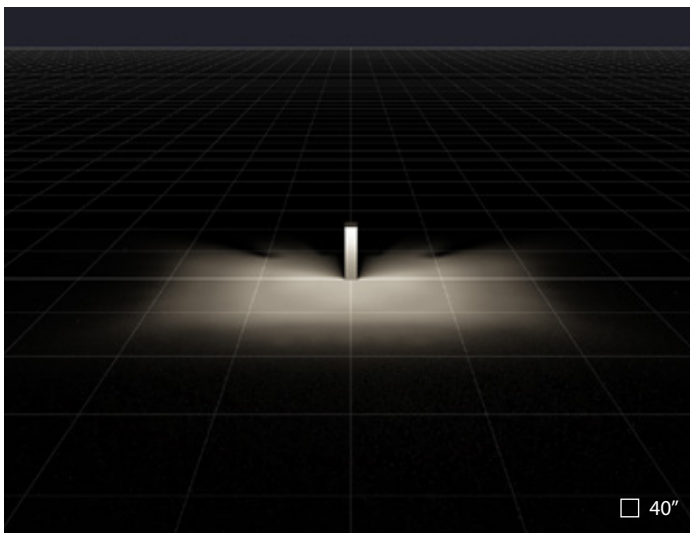

MIMIK 10 BOLLARD 600 | TYPE III

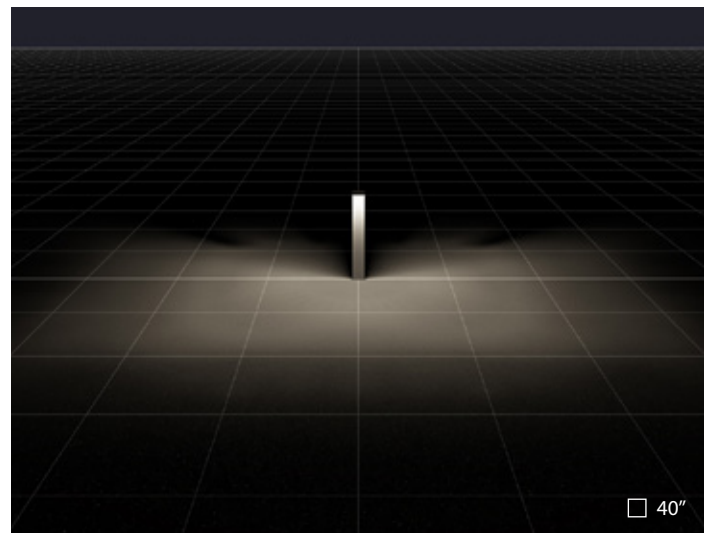

MIMIK 10 BOLLARD 1000 | TYPE III

PERFORMANCE
IN LIGHTING

powered by
GEWISS

PERFORMANCE IN LIGHTING
2621 Keys Pointe
Conyers, GA 30013 - United States
Ph 770.822.2115
Fax 770.822.9925

www.performanceinlighting.com