

# INSERT+ ZERO

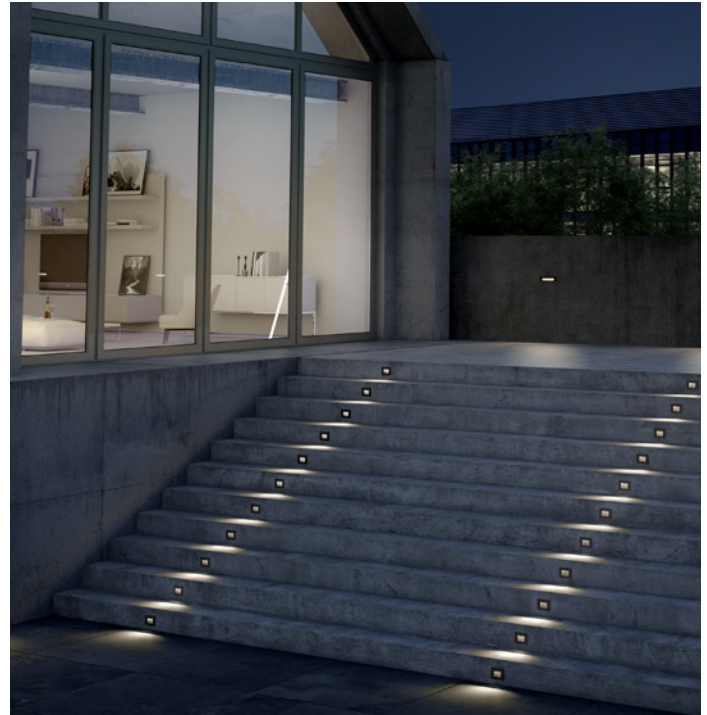
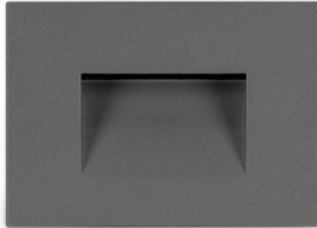

Recessed wall steplight series. Fixtures consist of:

- Multi-step powder-coat painting process, optimized against UV rays and corrosion.
- Copper-free precision die-cast aluminum housing and ring/faceplate.
- Frosted, flat, tempered silk-screened soda-lime glass diffuser.
- Custom molded, anti-aging gasket(s).
- Stainless steel external hardware.
- Custom MCPCB utilized to maximize heat dissipation and promote a long LED life.

- IESNA Type II light distribution.
- Input voltage: 120-277 V (50 / 60 Hz), integral driver.
- Mud Ring included for INSERT+ ZERO / ZERO CLIPS (J-Box provided by others).
- Consult factory for dimming options, custom finishes (please specify RAL color), and non-cataloged CCT (Kelvin) options including static colors.
- 5-year warranty.
- Marine Grade finish.
- Suitable for Natatorium applications.
- Consult factory for any Buy American Act (BAA) or Build America Buy America Act (BABAA) requirements.



## FINISHES

- AN-96 / Iron gray / Textured
- GR-94 / Aluminum metallic / Textured
- WH-87 / White / Textured
- BK-81 / Black / Textured
- RB-10 / Iron rust / Textured

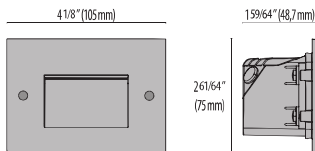

INSERT+  
ZERO

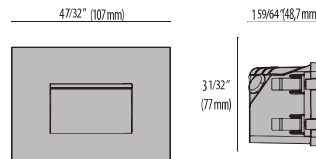

INSERT+  
ZERO CLIPS



Scan here  
for installation  
instructions

Lumen Output	27K	3K	35K	4K	5K	6K
Insert+Zero Screw 4W	134	140	146	153	159	165
Insert+Zero Screw 6W	184	188	192	196	200	204
Insert+Zero Clips 4W	154	162	170	178	186	194
Insert+Zero Clips 6W	213	217	221	225	229	233

\*Exclusions apply. See ordering matrix for details.

# Order Guide - Insert+Zero



Order code example

**IN0-SC-6W-AM-3K-120-NA**

**INO-**

Housing Style	Wattage	Finish	Kelvin	Voltage	Controls	Accessories	
SC Screw Version	Integral Driver Options	<b>AM</b> Aluminum Metallic	<b>27K</b> 2700k	<b>UNV</b> 120-277V	<b>NA</b> Non Dimming	<b>PHC*</b> Photocell	
	<b>4</b> 4 watt	<b>IG</b> Iron Gray	<b>3K</b> 3000k				
CL Clip Version	<b>6</b> 6 watt (max)	<b>IR</b> Iron Rust	<b>35K</b> 3500k		<b>0-10V</b> 0-10V Dimming (Remote Driver Only)See Below	<b>OCC*</b> Occupancy Sensor	
	<b>XX</b> Specify Wattage Must be below max	<b>BK</b> Textured Black	<b>4K</b> 4000k				
	Remote Driver Options	<b>2</b> 2 watt	<b>WH</b> Textured White				<b>5K</b> 5000k
		<b>3</b> 3 watt	<b>CC</b> Custom Color				<b>65K</b> 6500k
		<b>4</b> 4 watt	<b>AMW</b> Anti-Microbial White				<b>RED</b> Static Red
		<b>5</b> 5 watt					<b>GRN</b> Static Green
		<b>6</b> 6 watt					<b>BLU</b> Static Blue
							<b>AMB</b> Static Amber
							<b>RGBW</b> RGBW See Below for Control Details

80 CRI STANDARD - OTHER OPTIONS AVAILABLE



## For DarkSky Applications

SC Screw Version (Approved for Residential and Commercial DarkSky Applications)	(same as standard product. see above for details)	(same as standard product. see above for details)	<b>27K</b> 2700k	<b>UNV</b> 120-277V	<b>NA</b>	<b>PHC*</b>	
	Integral Driver	<b>AM</b>					<b>3K</b> 3000k
CL Clip Version (Approved for Residential DarkSky Applications)	Remote Driver	<b>IR</b>	<b>AMB</b> Static Amber		<b>ELV</b>	<b>ADP</b>	
		<b>BK</b>					<b>TP</b>
		<b>WH</b>					<b>GFCI</b>
		<b>CC</b>					<b>BABAA</b>
		<b>AMW</b>					

80 CRI STANDARD - OTHER OPTIONS AVAILABLE

Performance in Lighting reserves the right to make all necessary changes without prior notice.

Performance in Lighting - 2621 Keys Pointe - Conyers, Georgia 30013 - USA - voice 770.822.2115 - info.usa@pil.lighting  
www.performanceinlighting.com

**Revision 20**  
**11/25**

**JBOX BY OTHERS  
4x4x4 DOUBLE GANG BOX REQUIRED**

**MUDRING INCLUDED WITH FIXTURE**

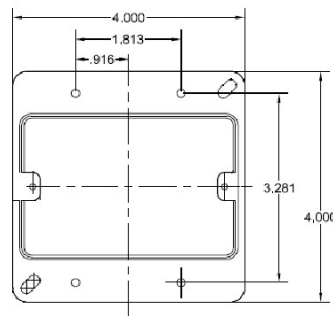
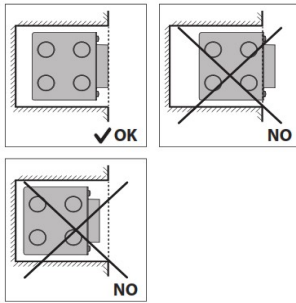
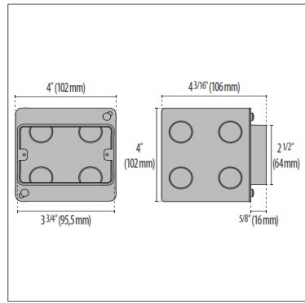

**PHC Option**



**OCC Option**

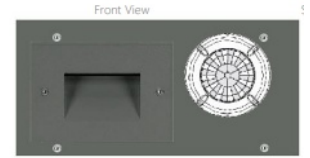

**RGBW ACCESSORIES**

**Power Supply**



**17433**  
Kit driver 48V



**17096**  
Kit driver 48V WP

**RF Controls**



**3104173**  
RGB RF controller 4 channel  
(0.35A each CH)



**31041730**  
RGB RF controller WP 4 channel  
(0.35A each CH)

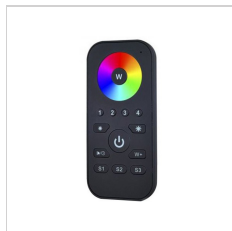

**310429**  
RGBW hand held remote

**DMX Controls**



**178973**  
RGB DMX enabler/decoder 4  
channel (0.35A each CH)



**1789730**  
RGB DMX enabler/decoder WP 4  
channel (0.35A each CH)



**11015**  
Terminating Resistor



**110150**  
Terminating Resistor WP

# INSERT+ ZERO REMOTE DRIVER OPTIONS

INSERT+ZERO ELV DRIVERS (REMOTE ONLY)		
FIXT QTY	4W / 350mA	6W / 500mA
1	n/a	17385
2	17390	n/a
3	17408	17470
4	17375	17409
5	17421	n/a
INSERT+ZERO 0-10V DRIVERS (REMOTE ONLY)		
FIXT QTY	4W / 350mA	6W / 500mA
1	17191 / 17244	17385
2	17390 / 17244	17320
3	17408	17470
4	17375	17263 / 17406 / 17409
5	17421	17488-500