

HEDO+ FT BOLLARD



Area and site lighting series. Fixtures consist of:

- Multi-step powder-coat painting process, optimized against UV rays and corrosion.
- Copper-free precision die-cast aluminum housing and top cap.
- Custom molded, anti-aging gasket(s).
- High-transmittance transparent optics.
- Extra-clear, tempered, silk-screened, flat glass diffuser.
- Stainless steel external hardware.
- Custom MCPCB utilized to maximize heat dissipation and promote a long LED life.
- IESNA Type II light distribution.
- IESNA Type V light distribution.
- Input voltage: 120-277V (50 / 60 Hz), integral 0-10 V dimming driver.
- Integral surge protector can withstand up to 10 kV transient line surge.
- Pre-wired factory sealed cable for external electrical connection included.

- Consult factory for dimming options, marine-grade, custom finishes (please specify RAL color), and non-cataloged CCT (Kelvin) options including static colors.
- Consult factory for custom pre-wired factory sealed cable length options.
- Consult factory for pole information.
- Consult factory for wall bracket accessory, multi-head pole top mounting, and other custom options.
- Product meets Buy American Act requirements within ARRA.
- 5-year warranty.
- Marine Grade finish.
- Suitable for Natatorium applications.



FINISHES

- BK-81 / Black / Textured
- AN-96 / Iron gray / Textured
- GR-94 / Aluminum metallic / Textured
- WH-87 / White / Textured
- RB-10 / Iron rust / Textured

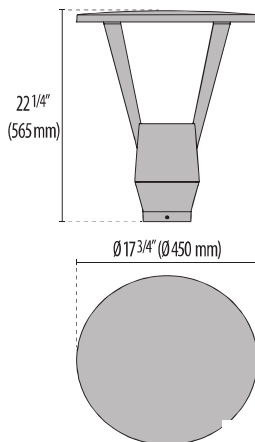

Lumen Output	3K	4K
Hedo+FT T2 6W	632	677
Hedo+FT T2 19W	2109	2258
Hedo+FT T2 27W	2945	3176
Hedo+FT T2 34W	3690	3971
Hedo+FT T2 40W	4291	4653
Hedo+FT T5 8W	890	936
Hedo+FT T5 18W	2077	2185
Hedo+FT T5 25W	2879	3024
Hedo+FT T5 25W	4132	4349
Hedo+FT T5 25W	4924	5189
Hedo+FT T5 25W	5319	5605



Scan here
for installation
instructions

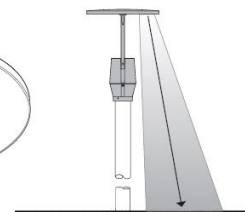
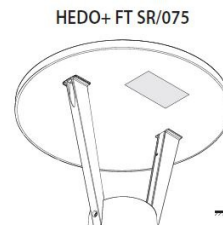
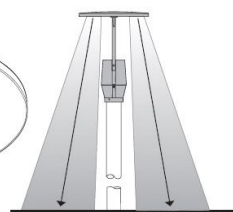
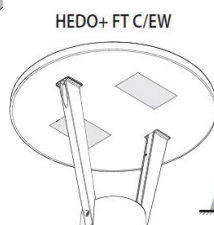

Revision 01
07/24

Order Guide - Hedo+ FT



Order code example

HFT- 27-T2-AM-3K-120-NA

HFT-

Wattage	Optics	Finish	Kelvin	Voltage	Controls	Accessories
<p>---T2---</p> <p>6 6 watt (T2 min)</p> <p>19 19 watt</p> <p>27 27 watt</p> <p>34 34 watt</p> <p>40 40 watt (T2 max)</p> <p>XX Specify wattage must be below max</p>	<p>T2 Type 2</p> <p>T5 Type 5</p>	<p>AM Aluminum Metallic</p> <p>IG Iron Gray</p> <p>IR Iron Rust</p> <p>BK Textured Black</p> <p>WH Textured White</p> <p>CC Custom Color</p>	<p>3K 3000K</p> <p>4K 4000K</p>	<p>UNV 120-277V</p>	<p>NA Non Dimming</p> <p>0-10V 0-10V Dimming</p> <p>ELV ELV Dimming</p>	<p>BOL Bollard 54"</p> <p>BABAA Build America Buy America Act compliant</p>
<p>---T5---</p> <p>8 8 watt (min)</p> <p>18 18 watt</p> <p>25 25 watt</p> <p>36 36 watt</p> <p>43 43 watt</p> <p>50 50 watt (max)</p> <p>80 80W 9000lm/4K (MOQ 15 Pieces T5 Only)</p> <p>XX Specify wattage must be below max</p>						

80 CRI STANDARD - OTHER OPTIONS AVAILABLE

Performance in Lighting reserves the right to make all necessary changes without prior notice.

Performance in Lighting - 2621 Keys Pointe - Conyers, Georgia 30013 - USA - voice 770.822.2115 - info.usa@pil.lighting
www.performanceinlighting.com

Revision 01
07/24

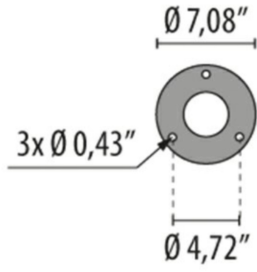

TEMPLATE/FIXING PLATE

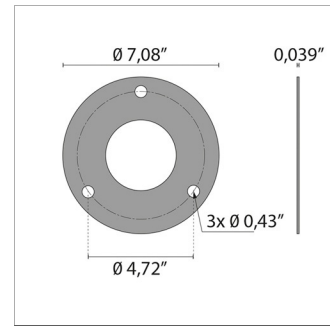

9395