



iN

# OFFICE

PERFORMANCE  
**iN** LIGHTING

powered by  
**GEWISS**



PERFORMANCE  
**in** LIGHTING | powered by  
**GEWISS**

Modern communication systems and flexible interior design adapt workplaces in the office continually. PERFORMANCE iN LIGHTING analyzes current trends in office and administration and derives the requirements for the development of its luminaires. The latest scientific findings for the effect of light on human biorhythm find their way into our luminaire & lighting design. Our LED Office luminaires have family characteristics, are flexible, and can be adjusted individually to accommodate lighting based on customers' needs.

# OFFICE

INDOOR OFFICE LIGHTING

## SUSPENDED

---

SL720



SL720 PL  
12

SL720 PL ROUND  
12

SL713+



SL713+ PL  
30

SMALL LINE



SMALL LINE PL  
40

SL629



SL629 PL  
84

## CEILING SURFACE MOUNTED

---

SL720



SL720 AB  
12

SL720 AB ROUND  
12

## CEILING RECESSED

---

SL764+



SL764+ RE  
102

SL787+



SL787+ RE  
116

SL629



SL629 AB  
84

SL630



SL630 AB  
92

SL764+



SL787+



LIQUID



IN-TENSE



MERCURY



SL764+ PL  
102

SL787+ PL  
116

LIQUID PL  
72

IN-TENSE PL  
50

MERCURY PL  
62

## FREE STANDING

SL720



SL720 SL L  
12



SL720 SL XL  
12



SL720 SL TWIN  
12

SMALL LINE



SMALL LINE SL  
40

# OFFICE

## SUITABLE LIGHTING FOR THE MODERN OFFICE

New technologies, global networking and the ways we communicate today are also changing what we require from our offices as workspaces. The modern office should be a place that inspires dialogue and ideas – and somewhere we can concentrate and enjoy a positive working atmosphere.

The modern office and its lighting should be:



### COMFORTABLE

We spend an average of eight hours a day in the workplace, often juggling multiple tasks. Increasingly, we seek to experience this space not only as a functional place of work, but also an exciting living space. Lighting is one of the most important factors creating a sense of wellbeing in a room – more than air conditioning and soundproofing or the aesthetics of the interior design: with the right lighting concept in place, a lively workplace atmosphere can be specifically evoked. Lighting solutions that recreate the dynamics of natural daylight also support the biological rhythm of our bodies and as such promote productivity.

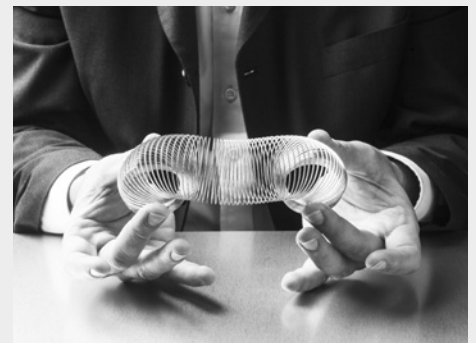

### FLEXIBLE

Flexibility is finding a place in all areas of working life today. Workplaces, working hours, team structures, and even floor plans are designed for easy adaptability. In the field of office design, the trend is moving away from individual or cubicle offices towards flexible room partitioning and open play layouts. Meeting areas and lounge areas promote communication and a creative atmosphere with intelligently programmed lighting control systems underlining the concept. With very little effort, lighting controls facilitate grouping lights into new configurations if the room partitions change.



## INDIVIDUAL

Permanent lighting that remains the same for all situations and employees, and which cannot be adjusted, is a thing of the past. Today's lighting control technology enables all employees to adjust their workspaces individually to suit their needs and moods. A positive side-effect of this is increased autonomy and personal influence for employees, boosting acceptance of a new lighting solution.



## DIGITAL

In the future, technology used in our workspaces and living spaces will be even more widely networked and routinely communicative than today – demand for networked, intelligent systems continues to grow rapidly. The intelligent control system by PERFORMANCE IN LIGHTING already makes it possible to control multiple functions within your building using one convenient tool. In addition, thanks to its intelligent swarm function, our lighting ensures you always have enough light in the office, wherever you are located.



## SUSTAINABLE

Electricity costs have been rising inexorably over recent years. Old, energy-guzzling lighting systems consume huge quantities of energy and expense, both in normal use and in maintenance terms. Today, however, pairing energy-efficient LED lights with intelligent, requirement-based controls makes it possible to produce cost- and resource-efficient lighting solutions that also offer improved light quality.

# OFFICE

## INDIVIDUAL REQUIREMENTS

At PERFORMANCE IN LIGHTING, people and their requirements are always in the forefront developing lighting concepts in collaboration with our customers. A perfect office lighting concept creates a positive, feelgood atmosphere. And of course, when you are feeling good, you can start thinking creatively. A lighting level that conforms to the required standards is as important in this respect as the harmonious interaction between light and shadow: high-contrast lighting helps us to better recognize objects and to maintain consistently high concentration levels as we work. Moreover, successful light planning can highlight special features within a space while blending seamlessly with the overall architectural appearance.



### INDIVIDUAL OFFICES

The individual office is one of the classic office types and still a popular configuration in many administrative buildings. HCL control solutions by PERFORMANCE IN LIGHTING make an individual office even more personal. Their flexible lighting scenarios enable employees to create their very own personal light space – a fully-lit room for example, or a cocoon of light around the desk. Luminaires with a broad illumination area, such as suspended lights with micro prism panes, are preferred choices; not simply because you can see where the light comes from, but also because they have a positive effect on biorhythms, in an HCL set-up.

### TWIN OFFICES

The lighting for a twin workspace needs to fulfil multiple requirements: even lighting that complies with relevant standards, pleasant illumination of the surfaces within the room, and optimal diffusion of the light right to the edges of the room. Excellent glare minimization is also a must for longer periods of concentrated working at a screen. Our luminaire family boasts all of these attributes.

### TRIPLE OFFICES

Adding a third desk to an office creates a special test of the luminaires' strength. Lighting families perform particularly well in this scenario. Using longer profile lengths and strip light configurations, these products offer great freedom of design and can adapt to the requirements. Our SL764/787+ families are particularly suitable for these situations.





## QUADRUPLE OFFICES

The best way to illuminate a group of four desks standing next to one another is using two floor luminaires at both ends. A daylight controller ensures that lighting is dimmed in areas of the room that are close to the window. This set up will allow the natural sunlight and artificial light to mesh particularly harmoniously, while also helping save energy. In modern offices, employees are often provided with height-adjustable desks to facilitate a healthy combination of sitting and standing; floor luminaires are especially suitable for these applications.



## OPEN-PLAN OFFICES

In open-plan offices, the lighting concept must strike a balance between individuality and community; this is so individual needs are met, but also to create an overall atmosphere that is perceived as pleasant. Open-plan offices need a lighting concept that accommodates individual workspaces and offers flexibility, while still achieving a harmonious overall concept. A broad family lighting portfolio is an advantage for this overall concept – that is exactly what our families SL629, SL630 and SL720 offer. Intelligent drivers in our floor and suspended luminaires use occupancy sensors or swarm functionality to offer an additional sense of security and wellbeing, while also reducing operating costs.



## MEETING ROOM

Light must often fulfil diverse demands in meeting rooms: You may want a prestigious atmosphere for customer meetings, a relaxed feel for team meetings or a stimulating effect to aid concentration for day-long seminars – and each of these situations requires a different lighting mood. Only a flexible lighting concept combined with a powerful lighting control system can cover all these varied applications. We can help to create this ideal environment by offering combinations of direct and indirect light, homogeneous illumination and stimulating accents, along with a selection of different light temperatures at the touch of a button.



## MORE OFFICE PRODUCTS

The PERFORMANCE iN LIGHTING product range offers even more solutions for the OFFICE area.

Please visit [www.performanceinlighting.com](http://www.performanceinlighting.com) for more information.



Volvo van Roosmalen | Veldhoven | Netherlands

### Downlights



DLSB100 LED

DLSB150 LED

DLSB185 LED

DLSB220 LED

MANGO+ MIDI

MANGO+ MAXI

DL ROUND MIDI

DL ROUND MAXI

DL SQUARE MINI

DL SQUARE MAXI



## MORE OFFICE PRODUCTS



Ayal Kaas company | Westzaan | Netherlands

Ceiling surface mounted



FL ROUND 333 AB    FL ROUND 555 AB    FL ROUND 777 SM    FL SQUARE 300 SM    FL SQUARE 600 SM

Ceiling recessed



AMIGO 36    PLATO SQUARE 600/625    FL ROUND 333 EB    FL ROUND 555 EB    FL ROUND 777 RE

Inlaid

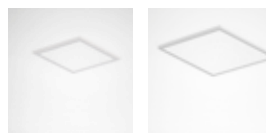

FL SQUARE 300 RE    FL SQUARE 600/625 IL

# SL720

## The evolution of a success story

Clean lines, slim design, elegant shadow gap, the fixture seemed to be floating in the room. This was the original T5 SL740 lighting family that we knew and loved. Recently, we redesigned our best-sellers for the LED era. They retain their timeless linear design but have been given a number of technical upgrades: They are now considerably more efficient thanks to our performance-optimised LED Sidelight technology and are even slimmer with only 20 mm installation height - this is the new SL 720 family today. Our innovative micro prism technology provides perfect glare prevention despite the slim design. The wide range of variants in the SL720 family allow planners the greatest freedom of design, and that's not all: our LIGHT-PERFORMER® can be used for custom configuration of luminaires. The control options also leave nothing to be desired with HCL, tunable white, daylight sensor or simple dimmable versions available.





ITV city | Wolfsburg | Germany

# SL720

Design-coordinated suspended (PL), surface mounted (AB) and free-standing (SL) series.  
Fixtures consist of:

## Construction

- Housing made of extruded aluminium profile or die-cast aluminium, powder coated
- Steel sheet canopy, painted
- Steel sheet base, powder painted (SL)
- Micro-prismatic diffuser for efficient light diffusion, glare reduction and a high uniformity
- Complete with steel suspension cable (1.5 m), transparent power cord and canopy (PL)
- Flexible power cord with plug (SL)

## Electrical

- Colour rendering index Ra > 80
- Colour tolerance according to MacAdam  $\leq 3$  SDCM
- LED Sidelight-Technology for a homogenous light distribution over the entire area of the cover
- Intelligent lighting control systems (daylight sensor, dimSMART!, Human Centric Lighting, TuneableWhite, DALI and emergency light) available
- Dimmable via TouchDIM®

## Versions

- 3000 K colour temperature version on demand
- Continuous mounted version at [www.light-performer.com](http://www.light-performer.com)
- Special colour versions available upon request

## Listings

- Made in Germany
- VDU application suitable acc. to EN 12464-1
- CE
- EAC
- ENEC
- For the innovative lighting technology of these lights patent is applied for (No. 10201511701.2)

## Warranty

- 5-year limited warranty.  
Complete warranty terms located at [www.performanceinlighting.com](http://www.performanceinlighting.com)





## SL720



SL720PL LED  
MICROPRISMA



SL720AB LED  
MICROPRISMA

CONSTRUCTION			
IP		IP 20	IP 20
IK		IK05 0.70J xx3	IK05 0.70J xx3
Dimensions (mm)		1225/1525 x 230 x 20	1225/1525 x 230 x 20
Weight		Max 7 kg	Max 8 kg
Colour		○ ●	○ ●
INSTALLATION			
Continuous mounted luminaire		✓	✓
LED			
Lightsource lumen output	3000 K	-	-
	4000 K	8000 lm ÷ 11050 lm	5900 lm ÷ 7350 lm
Luminaire lumen output	3000 K	-	-
	4000 K	5660 lm ÷ 7920 lm	3860 lm ÷ 4470 lm
CCT - Correlated Color Temperature		4000 K	4000 K
CRI / SDCM (macadam step)		80/3	80/3
Lifetime		L80B10@50000h	L80B10@50000h
OPTIC			
S/C – symmetric uniform direct-indirect light		S/C 2 x 48° ÷ 2 x 48°/47°	-
S/B – symmetric mainly direct lighting		-	S/B 2 x 42°/43° ÷ 2 x 45°/44°
UFF (Upward Flux Fraction)		62 %	1 %
DFF (Downward Flux Fraction)		38 %	99 %
ELECTRICAL			
Wattage		45 W - 59 W - 67 W	34 W - 40 W
Class		I	I
EEL		A1 - A2	A1 - A2
Dimmable DALI		✓	✓
Emergency		-	-
COSφ ≥ 0,9		✓	✓
CONTROL SYSTEMS			
Infrared motion sensor - IR		on request	on request
DIM SMART (bluetooth)		-	-
STANDARDS			
DIN EN 12464-1		✓	✓



SL720PL ROUND LED MICROPRISMATIC  
S - M - L



SL720AB ROUND LED MICROPRISMATIC  
S - M - L

	IP 20	IP 20
	IK05 0.70J xx3	IK05 0.70J xx3
	Ø 322 - Ø 552 - Ø 730	Ø 322 - Ø 552 - Ø 730
	Max 3 kg - Max 5 kg - Max 7 kg	Max 4 kg - Max 7 kg - Max 12 kg
	○ ●	○ ●
	-	-
	3010 lm ÷ 7760 lm	4270 lm ÷ 5630 lm
	3100 lm ÷ 8000 lm	4400 lm ÷ 5800 lm
	2600 lm ÷ 6600 lm	3280 lm ÷ 4370 lm
	2680 lm ÷ 6810 lm	3380 lm ÷ 4500 lm
	3000 K / 4000 K	3000 K / 4000 K
	80/3	80/3
	L80B10@50000h	L80B10@50000h
	-	-
	S/C 2 x 51°/50° ÷ 2x50°	-
	-	S/B 2 x 48° ÷ 2 x 48°/47°
	62 %	2 %
	38 %	98 %
	26 W - 50 W - 76 W	12 W / 26 W - 34 W / 50 W - 48 W / 76 W
	I	I
	A1 - A2	A1 - A2
	✓	✓
	on request	on request
	✓	✓
	-	-
	-	-
	✓	✓

## SL720



SL720SL L LED  
MICROPRISMA



SL720SL L ECO LED  
MICROPRISMA

CONSTRUCTION		
IP	IP 20	IP 20
IK	IK05 0.70J xx3	IK05 0.70J xx3
Dimensions (mm)	705 x 430 x 2042	705 x 430 x 2042
Weight	Max 16 kg	Max 16 kg
Colour	○ ●	○ ●
INSTALLATION		
Continuous mounted luminaire	-	-
LED		
Lightsource lumen output	2700-6200 K	10120 lm
	4000 K	13660 lm
Luminaire lumen output	2700-6200 K	11500 lm
	4000 K	15500 lm
CCT - Correlated Color Temperature	2700-6200 K / 4000 K	4000 K
CRI / SDCM (macadam step)	80/3	80/3
Lifetime	L80B10@50000h	L80B10@50000h
OPTIC		
S/D – symmetric mainly indirect lighting	S/D 2 x 43°	-
S/C – symmetric uniform direct-indirect light	S/C 2 x 43°	S/C 2x44°
UFF (Upward Flux Fraction)	87 %	57 %
DFF (Downward Flux Fraction)	13 %	43 %
ELECTRICAL		
Wattage	85 W - 114 W	82 W
Class	I	I
EEL	A1 - A2	A1
Dimmable DALI	✓	✓
COSφ ≥ 0,9	✓	✓
CONTROL SYSTEMS		
Infrared motion sensor - IR	✓	✓
DIM SMART (bluetooth)	-	-
HCL	✓	-
Tunable White	✓	-
STANDARDS		
DIN EN 12464-1	✓	✓



SL720SL L D+ LED  
MICROPRISMA



SL720SL XL LED  
MICROPRISMA



SL720SL XL D+ LED  
MICROPRISMA



SL720SL L TWIN LED  
MICROPRISMATIC COVER

SL720SL L D+ LED MICROPRISMA	SL720SL XL LED MICROPRISMA	SL720SL XL D+ LED MICROPRISMA	SL720SL L TWIN LED MICROPRISMATIC COVER
IP 20	IP 20	IP 20	IP 20
IK05 0.70J xx3	IK05 0.70J xx3	IK05 0.70J xx3	IK05 0.70J xx3
705 x 430 x 2042	1006/1035 x 500 x 2042	1006/1035 x 500 x 2044	735 x 869 x 2064
Max 16 kg	Max 17 kg	Max 17 kg	Max 20 kg
○●	○●	○●	○●
-	-	-	-
11820 lm	14300 lm	17800 lm	-
15590 lm	19560 lm	23520 lm	15010 lm
13800 lm	15800 lm	19700 lm	-
17400 lm	22250 lm	26750 lm	17000 lm
2700-6200 K / 4000 K	2700 - 6200 K / 4000 K	2700 - 6200 K / 4000 K	4000 K
80/3	80/3	80/3	80/3
L80B10@50000h	L80B10@50000h	L80B10@50000h	L80B10@50000h
-	S/D 2 x 43°	-	S/D 2 x 43°
S/C 2 x 44°/44°	-	S/C 2 x 43°	-
77 %	89 %	77 %	75 %
23 %	11 %	23 %	25 %
105 W - 132 W	118 W - 166 W	169 W - 212 W	140 W
I	I	I	I
A1	A1 - A2	A1 - A2	A1
✓	✓	✓	-
✓	✓	✓	✓
✓	✓	✓	✓
-	-	-	-
✓	✓	✓	-
✓	✓	✓	-
✓	✓	✓	✓

SL720PL ROUND LED / SL720AB ROUND LED



Variable uses and combinations thanks to a wide range of variants



The functional canopy keeps the quick-action suspension brackets of the cable suspension hidden and enables quick and convenient installation thanks to its magnetic cover



The innovative microprism combined with proven sidelight technology ensures outstanding visual comfort and glare-free light in the workplace



Surface-mounted version ensures attractive ceiling illumination



Suitable for use in a computer environment in accordance with DIN EN 12464-1

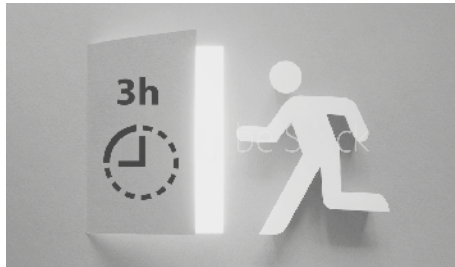

Versions with emergency upon request

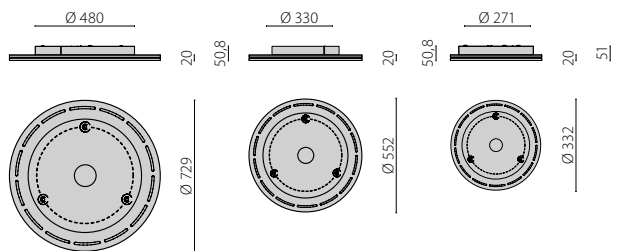
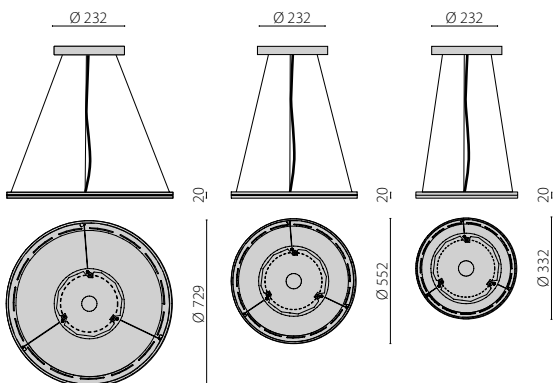



Sparkasse Mittelmosel EMH | Bernkastel-Kues | Germany

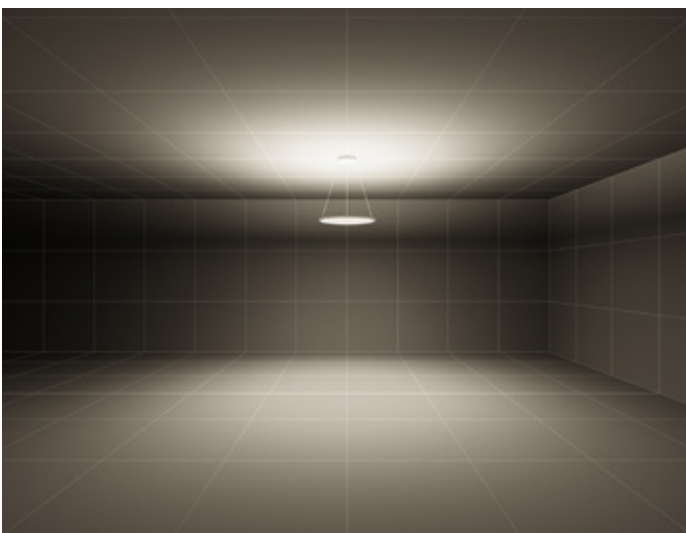

S/C – symmetric uniform direct-indirect light

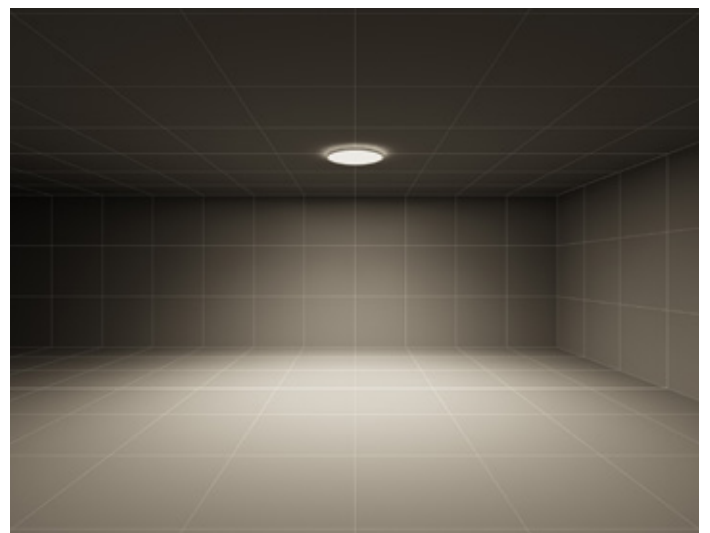

S/B – symmetric mainly direct lighting

SL720PL LED / SL720AB LED



The minimalist technical design of the the SL720 is characterised by an extremely slender silhouette with the classic shadow gap to reduce the optical height

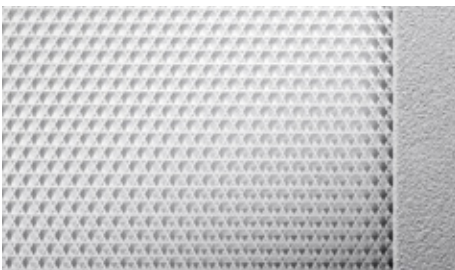

The innovative microprism combined with proven sidelight technology ensures outstanding visual comfort and glare-free light in the workplace.



Sensor device available with task oriented PIR detector and daylight control upon request



Bluetooth sensor component for use with dimSMART! light control upon request



Suitable for use in a computer environment in accordance with DIN EN 12464-1



Individual strip light solutions can be configured with ease using our LIGHT-PERFORMER®



Surface-mounted version

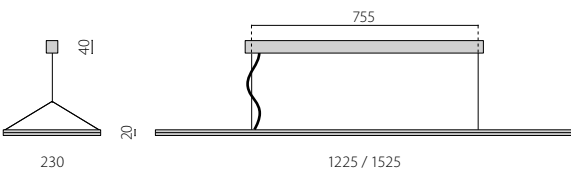



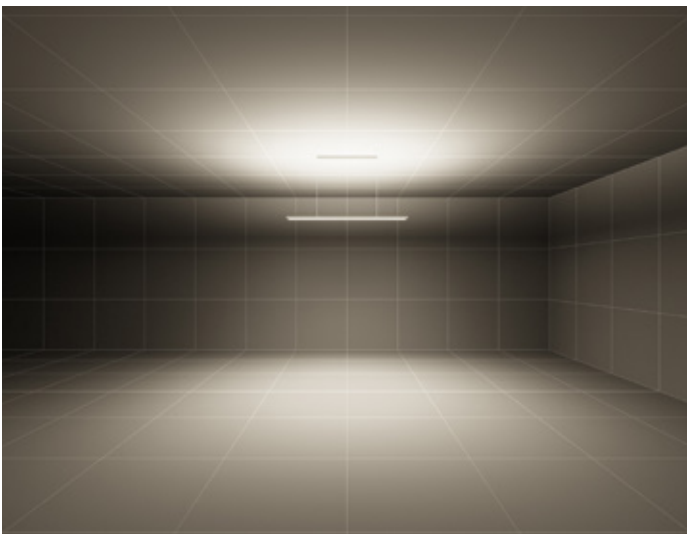

S/C – symmetric uniform direct-indirect light

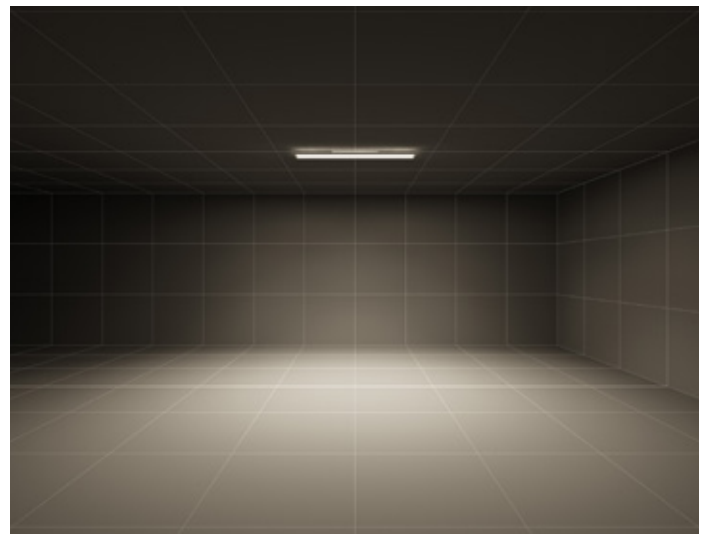

S/B – symmetric mainly direct lighting

SL720SL L LED / SL720SL XL LED



The HCL version reproduces the dynamic cycle of daylight in the indirect component, and varies the illuminance level and light colour between 2,700 K and 6,200 K depending on the time of day



Daylight sensors ensure substantial energy savings and support user health and wellbeing



Direct and indirect light sources can be separately dimmed with absolute ease using our intelligent switch. This switch can also be used to control the light colour and sensors

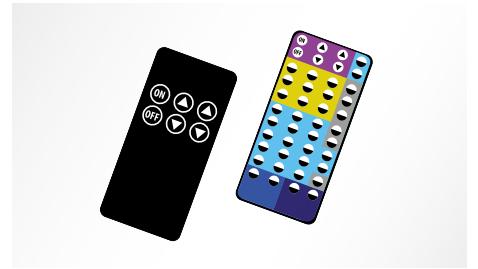

Whether you opt for a user remote control or detailed sensor and scenario programming, our remote operation range offers a wide range of functions



Suitable for use in a computer environment in accordance with DIN EN 12464-1



Practical U-shaped base allows for easy, level positioning of the luminaire and offers maximum flexibility



The XL version can be used to illuminate twin workspaces perfectly

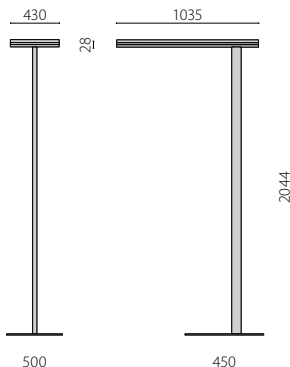
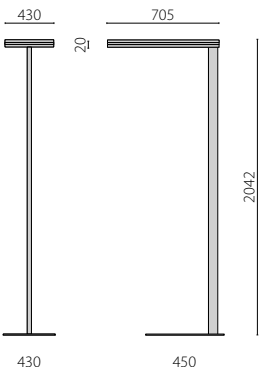



TAZ Berlin headquarters | Berlin | Germany

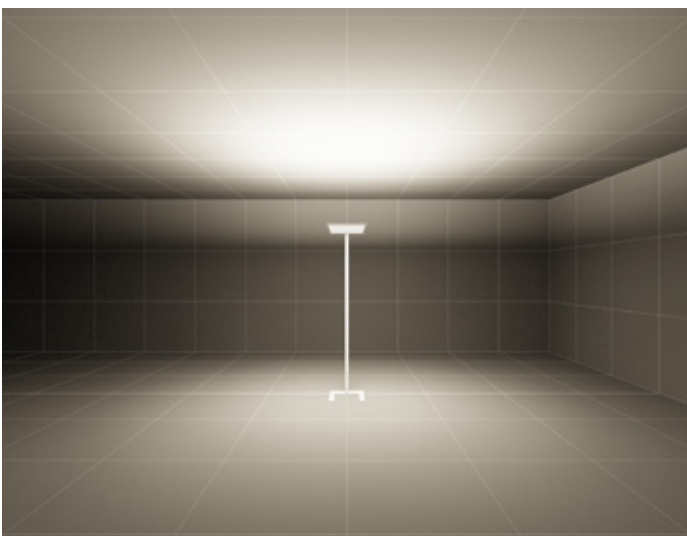

S/D – symmetric mainly indirect lighting

## SL720SL TWIN



The slender double head with its intelligent dimensions ensures maximum visual comfort and perfect illumination of twin workspaces



Practical U-shaped base allows for easy, level positioning of the luminaire and offers maximum flexibility



Daylight sensors ensure substantial energy savings and support user health and wellbeing



Direct and indirect light sources can be separately dimmed with absolute ease using our intelligent switch. This switch can also be used to control the sensors



Suitable for use in a computer environment in accordance with DIN EN 12464-1



The innovative microprism combined with proven sidelight technology ensures outstanding visual comfort and glare-free light in the workplace



Whether you opt for a user remote control or detailed sensor and scenario programming, our remote operation range offers a wide range of functions

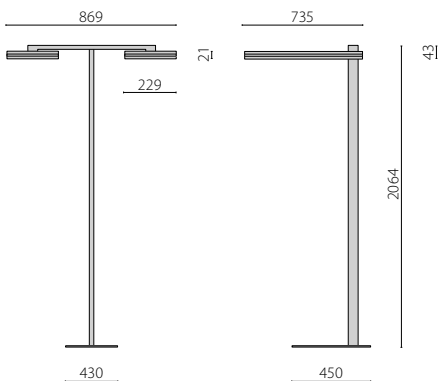



Insurance "Alte Leipziger" | Oberursel | Germany

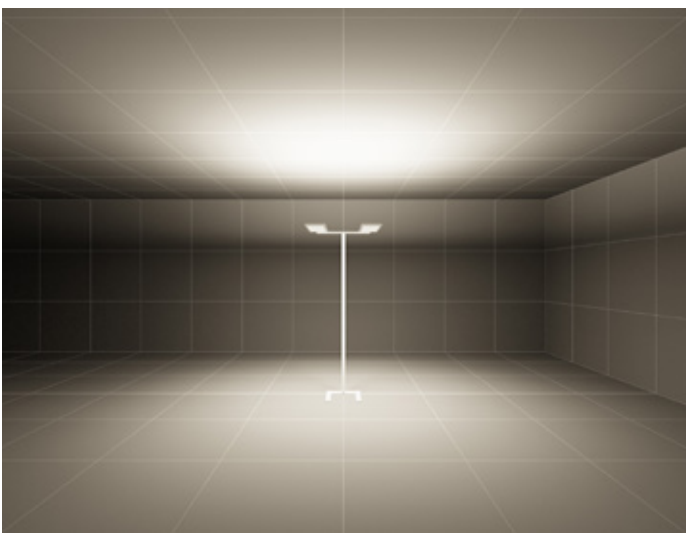

S/D – symmetric mainly indirect lighting



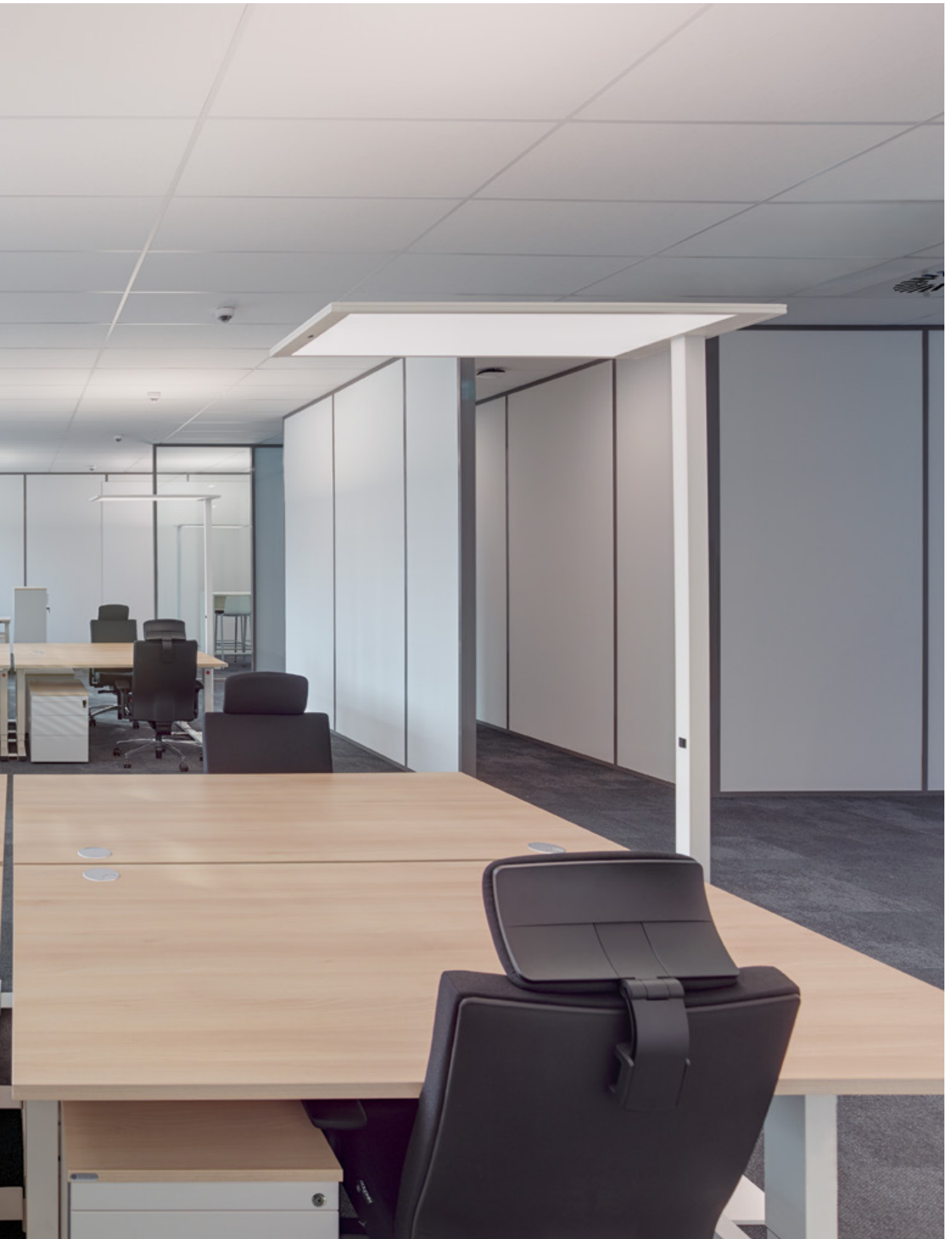

ITV city | Wolfsburg | Germany

# SL713+

Astonishingly slim –  
astoundingly versatile

Introducing our most slender luminaire: the SL713+. With just 13 mm of thickness - as thin as a matchbox – the delicate appearance of our new SL713+ series sets new standards in design. Its timeless simplicity is skilfully hidden to allow the exceptional light quality to take centre stage. Hard to believe, but this wafer-thin luminaire is pure power: It achieves an extremely high efficiency of 130 lm/W thanks to sophisticated LED Sidelight technology. Installing the luminaires is quick and intuitive and the separate LED module can be easily replaced at a later time if needed. All this makes the SL713+ a true “future proof” solution. This makes the range ideal for classic office applications as well as for stylish illumination of meeting spaces and prestigious areas that must be illuminated using glare-free options in line with DIN EN 12464-1. The control options also leave nothing to be desired with HCL, tunable white, dimSMART! or simple dimmable versions available.







Casa EMERGENCY | Milan | Italy

# SL713+

LED suspended luminaire for interior, comprising:

## Construction

- Aluminium profile lightframe, steel sheet canopy, painted
- Micro-prismatic diffuser for efficient light diffusion, glare reduction and a high uniformity
- Complete with steel suspension cable (1.5 m), transparent power cord and canopy
- The LED modules can be changed on site in just a few simple steps. Thanks to the innovative plug & play connector of the supply line, this is also possible without a qualified electrician.

## Electrical

- Colour rendering index Ra > 80
- Colour tolerance according to MacAdam  $\leq 3$  SDCM
- LED Sidelight-Technology for a homogenous light distribution over the entire area of the cover
- Intelligent lighting control systems (daylight sensor and DALI) available
- Dimmable via TouchDIM®

## Variants

- With the OSRAM BT Bluetooth control, the light can be easily configured, personalised or grouped via the app using various parameters
- In the tunable white version, the illuminance level and light colour can be manually adjusted from 2,700 K to 6,500 K depending on the time of day (DALI DT8)
- En la versión HCL, se pueden regular el nivel de iluminancia y el color de la luz de 2700 a 6500 K en función de la hora del día con control de tiempo
- Special colour versions available upon request

## Listings

- Made in Germany
- VDU application suitable acc. to EN 12464-1
- CE
- ENEC

## Warranty

- 5-year limited warranty. Complete warranty terms located at [www.performanceinlighting.com](http://www.performanceinlighting.com)





SL713+PL

**CONSTRUCTION**

IP	IP 20
IK	IK05 0.70J xx3
Dimensions (mm)	1262/1562 x 264 x 13mm
Weight	Max 5,6 kg
Colour	○ ●

**INSTALLATION**

Continuous mounted luminaire	-
------------------------------	---

**LED**

Lightsource lumen output	2700-6500 K	-
	3000 K	-
	4000 K	-
Luminaire lumen output	2700-6500 K	6320 lm ÷ 8040 lm
	3000 K	6930 lm ÷ 9010 lm
	4000 K	6930 lm ÷ 8680 lm
CCT - Correlated Color Temperature	2700-6500 K - 3000K - 4000 K	
CRI / SDCM (macadam step)	80/3	
Lifetime	L80B10@50000h	

**OPTIC**

S/C – symmetric uniform direct-indirect light	S/C 2 x 43°/45° ÷ 2 x 45°/46° ÷ 2 x 44°/45°
UFF (Upward Flux Fraction)	63 %
DFF (Downward Flux Fraction)	37 %

**Elektrische Eigenschaften**

Leistung	53 W - 68 W - 69 W
Klasse	I
EEL	A1 - A2
Dimmbar DALI	✓
COSφ ≥ 0,9	✓

**CONTROL SYSTEMS**

Infrared motion sensor - IR	✓
Bluetooth control	✓
HCL	✓
Tunable White	✓

**STANDARDS**

DIN EN 12464-1	✓
----------------	---



Casa EMERGENCY | Milan | Italy

## SL713+ PL



Super-slim luminaire series in a functional, stylish look.

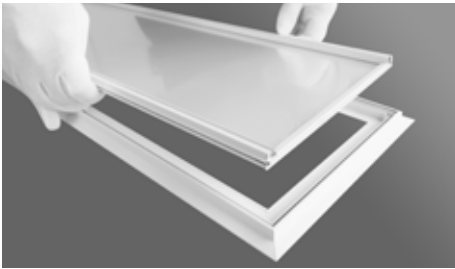

The LED modules can be changed on site and without a qualified electrician in just a few simple steps.

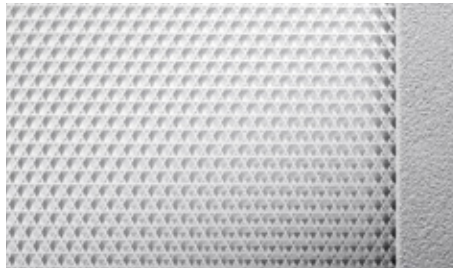

The innovative microprism combined with proven sidelight technology ensures outstanding visual comfort and glare-free light in the workplace.



The ceiling distance can be adjusted easily and flexibly, using our functional cable suspension



Suitable for use in a computer environment in accordance with DIN EN 12464-1.



With the Bluetooth control, the light can be easily configured, personalised or grouped via the app using various parameters.



The HCL and tunable white versions reproduce the dynamic cycle of daylight and vary in illuminance level and light colour from 2,700 K to 6,500 K depending on the time of day.

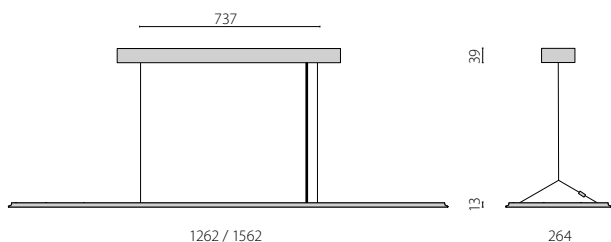



Microsoft headquarters | Munich | Germany

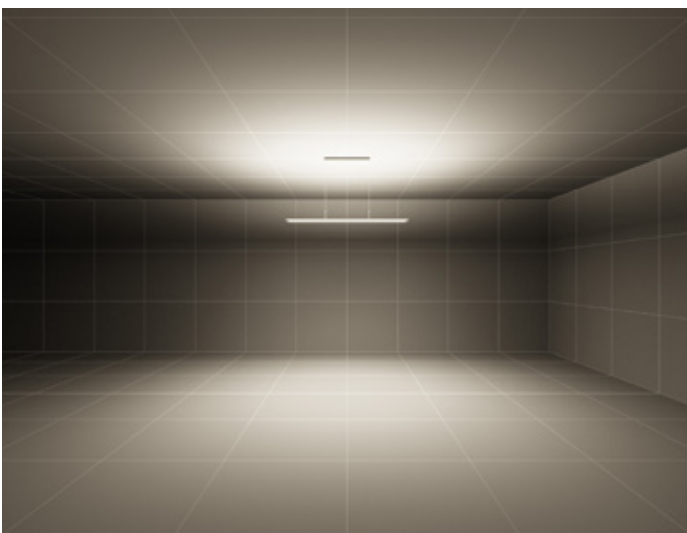

S/C – symmetric uniform direct-indirect light







CASA EMERGENCY | Milan | Italy

# SMALL LINE

Innovation done right -  
anything but ordinary!

Innovative and unusual – this is the perfect definition of our Small Line. The highest expression of minimalism. What stands out is a unique and unparalleled design: slim light lines and open spaces. This airy lighting family of suspended and floor luminaires was awarded the 2019 reddot Design Award. An eyecatcher in any room designed to make a statement. The design is carefully created to the smallest detail: no power cables spoil the look of this design; the suspended light is connected to the power supply through the suspension cable. Despite the slender housing height, both direct and indirect lights are incorporated in the small lines of light. The high efficiency multifaceted reflectors are anti-glare in line with norms. If you need to customize the standard lengths, simply use the LIGHT-PERFORMER® to configure your personal strip light solution.



**reddot** award 2019  
winner





# SMALL LINE

Design-coordinated suspended (PL) and free-standing (SL) series. Fixtures consist of:

## Construction

- Extruded aluminium profile housing, die-cast aluminium end caps, painted
- Steel sheet canopy, painted
- Steel sheet base, powder painted
- Slender plates with open spaces give the luminaire a uniquely delicate design
- Gear tray with high-shine multifaceted reflectors made of pure aluminium for maximum luminaire efficiency and neutral colour rendering
- Power is supplied via the cable suspension, no additional supply cable is required(PL)
- Flexible power cord with plug (SL)

## Electrical

- Colour rendering index Ra > 80
- Colour tolerance according to MacAdam  $\leq 3$  SDCM
- Intelligent lighting control systems (daylight sensor, dimSMART! and DALI) available
- Dimmable via TouchDIM®

## Variants

- Continuous mounted version at [www.light-performer.com](http://www.light-performer.com)
- Special colour versions available upon request

## Listings

- Made in Germany
- VDU application suitable acc. to EN 12464-
- CE
- EAC

## Warranty

- 5-year limited warranty.  
Complete warranty terms located at [www.performanceinlighting.com](http://www.performanceinlighting.com)



## SMALL LINE



SMALL LINE PL REFLECTOR



SMALL LINE SL REFLECTOR

CONSTRUCTION			
IP		IP 20	IP 20
IK		IK05 0.70J xx3	IK05 0.70J xx3
Dimensions (mm)		1256/1556 x 132 x 26	956/976 x 252 x 2042
Weight		Max 2 kg	Max 10,7 kg
Colour		○ ●	○ ●
INSTALLATION			
Continuous mounted luminaire		✓	-
LED			
Lightsource lumen output	3000 K	6460 lm ÷ 9540 lm	6940 lm ÷ 9390 lm
	4000 K	8540 lm ÷ 12610 lm	9410 lm ÷ 12710 lm
Luminaire lumen output	3000 K	6660 lm ÷ 9830 lm	7150 lm ÷ 9680 lm
	4000 K	8800 lm ÷ 13000 lm	9700 lm ÷ 13100 lm
CCT - Correlated Color Temperature		3000 K / 4000 K	3000 K / 4000 K
CRI / SDCM (macadam step)		80/3	80/3
Lifetime		L80B10@50000h	L80B10@50000h
OPTIC			
S/C – symmetric uniform direct-indirect light		S/C 2 x 37°	S/C 2 x 42° ÷ 2 x 42°/42°
UFF (Upward Flux Fraction)		60 %	53 %
DFF (Downward Flux Fraction)		40 %	47 %
ELECTRICAL			
Wattage		57 W - 69 W - 71 W - 87 W	63 W - 88 W
Class		I	I
EEL		A1 - A2	A1 - A2
Dimmable DALI		✓	✓
COSφ ≥ 0,9		✓	✓
CONTROL SYSTEMS			
Infrared motion sensor - IR		✓	✓
DIM SMART (bluetooth)		✓	-
STANDARDS			
DIN EN 12464-1		✓	✓



## SMALL LINE PL



Slender plates with open spaces give the luminaire a uniquely delicate design.

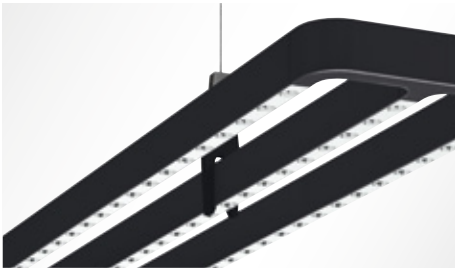

Power is supplied via the cable suspension, no additional supply cable is required.



The luminaire unit is attached to the cable suspension without tools using clips.



Light optics with high-shine multifaceted reflectors ensure maximum efficiency and light quality



Daylight sensors ensure substantial energy savings and support user health and wellbeing.



dimSmart! can be used to configure and personalise the light easily via app, using various parameters – so it suits your needs perfectly.



**reddot** award 2019  
winner

The suspended lights in this range received the reddot design award in the "Lights and luminaires" category in 2019.

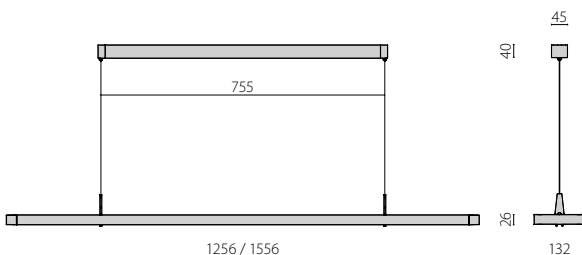



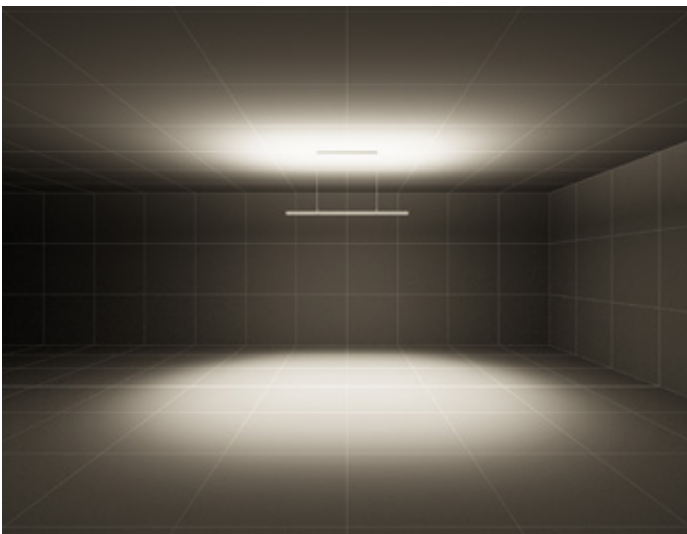

S/C – Symmetric uniform direct-indirect light

## SMALL LINE SL



Slender plates with open spaces give the luminaire a uniquely delicate design.



Practical U-shaped base allows for easy, level positioning of the luminaire and offers maximum flexibility.



Direct and indirect light sources can be separately dimmed with absolute ease using our intelligent switch. This switch can also be used to control the sensors



Light optics with high-shine multifaceted reflectors ensure maximum efficiency and light quality



Daylight sensors ensure substantial energy savings and support user health and wellbeing.



Suitable for use in a computer environment in accordance with DIN EN 12464-1.

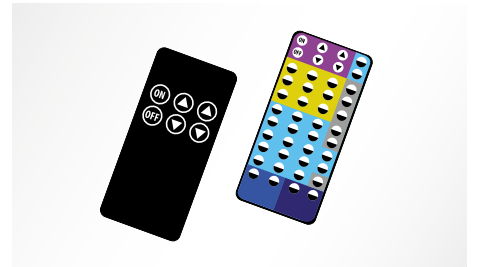

Whether you opt for a user remote control or detailed sensor and scenario programming, our remote operation range offers a wide range of functions

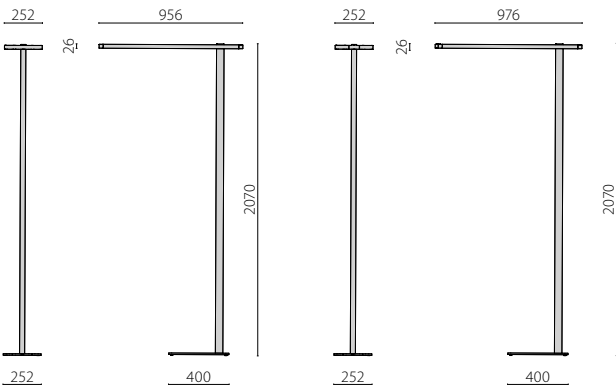

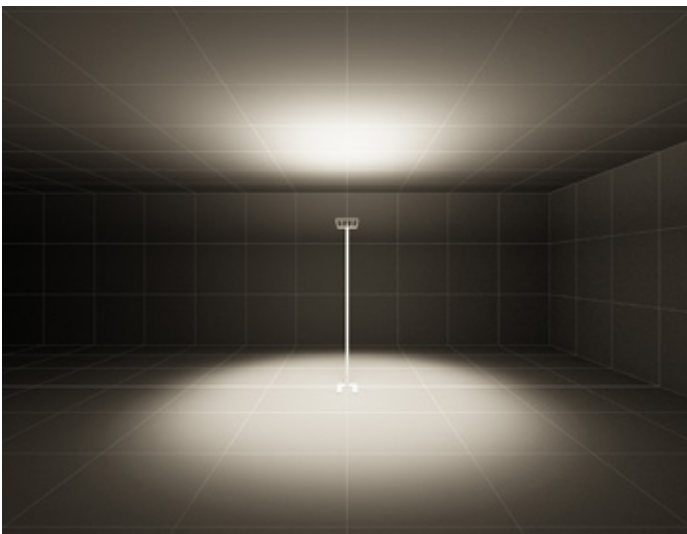

S/D – symmetric mainly indirect lighting

# IN-TENSE

design Walter de Silva

## Exclusive, Sculptural, Disruptive

Ethereal and light but intense. IN-TENSE, designed by Walter de Silva for PERFORMANCE iN LIGHTING, embodies the perfect combination of dynamism and fluidity. The almost skin-like tension of the material explodes in a three-dimensional creation, whose sophisticated line evolves and composes volumes in motion, while a meditated asymmetry regains the uniqueness of the essential natural element we know as light.

Simple, functional and modern on one hand and exclusive, sculptural, disruptive are the concepts behind this series: the light seems to flow from the ceiling into a bi-dimensional free space.

A sculptural and disruptive metal feeling underlines the status of futuristic appearance able to express digitalisation emphasising the precision for details.

An organic, warm, romantic technical revolution is the concept behind this new object of German quality.





Private house | Verona | Italy

# IN-TENSE

Suspended, LED luminaire for indoor, comprising:

## Construction

- Tempered, flat glass diffuser with thermoformed technopolymer housing
- LED Sidelight-Technology for a homogenous light distribution over the entire area of the cover
- High transparent glass with a white ceramic edge (WHITE TR) and integrated micro prism for efficient light diffusion, glare minimisation, and excellent uniformity
- High transparent glass with a black ceramic edge (BLACK TR) and integrated micro prism diffuser for efficient light diffusion, glare minimisation, and excellent uniformity
- Partially mirrored, black glass with a black ceramic edge (BLACK DRK) and integrated micro prism for efficient light diffusion, glare minimisation, and excellent uniformity
- Pendant metal tube and suspension cable on one side only, with drop-shaped die-cast coupling

## Electrical

- Dimmable via TouchDIM®
- Colour tolerance according to MacAdam  $\leq 3$  SDCM

## Installation

- Pendant tube, cable suspension, supply cable and ceiling canopy included

## Variants

- Special colour versions available. Consult factory

## Listings

- CE
- EAC
- ENEC
- VDU application suitable acc. to EN 12464-1
- Made in Germany

## Warranty

- 5-year limited warranty. Complete warranty terms located at [www.performanceinlighting.com](http://www.performanceinlighting.com)
- Registered design ®





		IN-TENSE
<b>CONSTRUCTION</b>		
IP		IP20
IK		IK04 0,50J xx3
Dimensions (mm)		1753 x 347 x 1000 mm
Weight		Max 8,5 kg
Colour		
<b>INSTALLATION</b>		
Continuous mounted luminaire		-
<b>LED</b>		
Lightsource lumen output	3000 K	11250 lm ÷ 13100 lm
	4000 K	11600 lm ÷ 13500 lm
Luminaire lumen output	3000 K	6710 lm ÷ 8390 lm
	4000 K	6920 lm ÷ 8650 lm
CCT - Correlated Color Temperature		3000 K - 4000 K
CRI / SDCM (macadam step)		80/3
Lifetime		L80B10@50000h
<b>OPTIC</b>		
S/D symmetric mainly indirect lighting		S/D 2 x 48°/46° ÷ S/D 2 x 49°
UFF (Upward Flux Fraction)		89 % ÷ 64 %
DFF (Downward Flux Fraction)		11 % ÷ 36 %
<b>ELECTRICAL</b>		
Wattage		78 W - 95 W
Class		I
EEl		A1 - A2
Ta MAX° luminarie		40°
Ta MIN° luminarie		10°
Dimmable DALI		✓
Emergency		-
COSφ ≥ 0,9		✓
<b>CONTROL SYSTEMS</b>		
Infrared motion sensor - IR		on request
<b>STANDARDS</b>		
EN 12464-1		✓



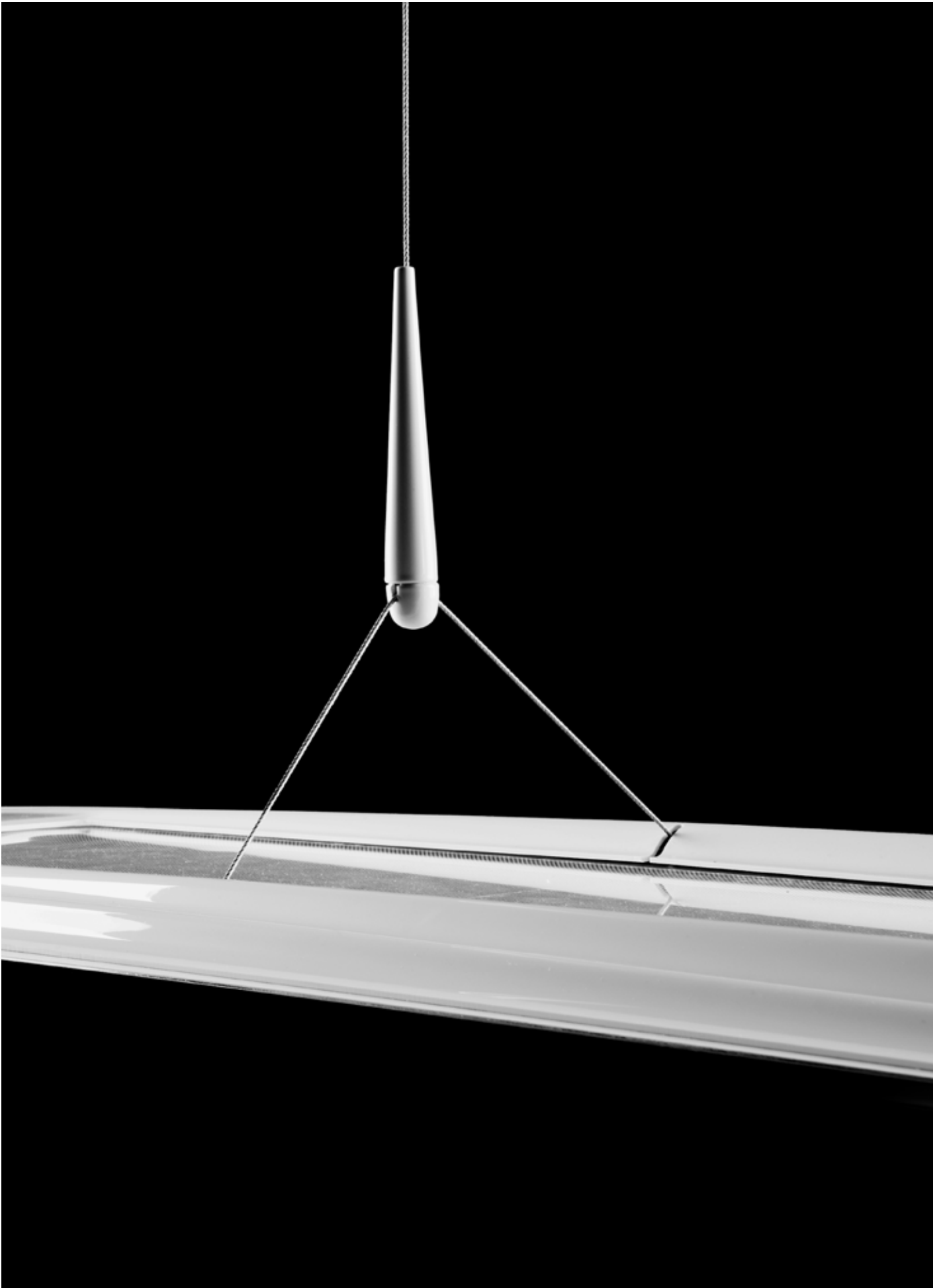





**IN-TENSE PL**



Direct/indirect-beam light distribution for an improved room atmosphere and increased visual comfort



Tempered, flat glass diffuser with thermoformed technopolymer housing



Luminaire head made from glass with moulded design cover in a wave shape and drip applications made from metal, as well as a diecast canopy



Sensor device available with task oriented PIR detector and daylight control upon request

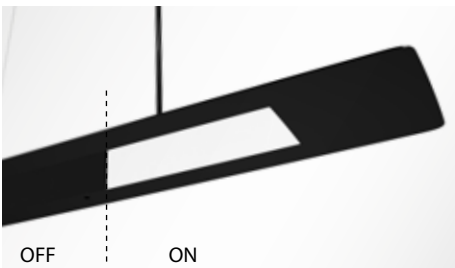

Partially mirrored, black glass with a black ceramic edge (BLACK DRK) and integrated micro prism for efficient light diffusion, glare minimisation, and excellent uniformity

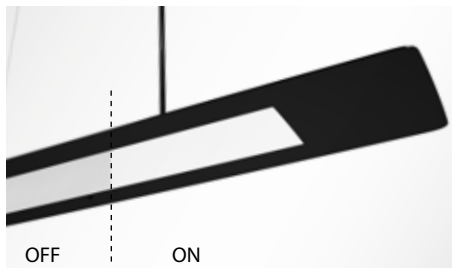

High transparent glass with a black ceramic edge (BLACK TR) and integrated micro prism diffuser for efficient light diffusion, glare minimisation, and excellent uniformity

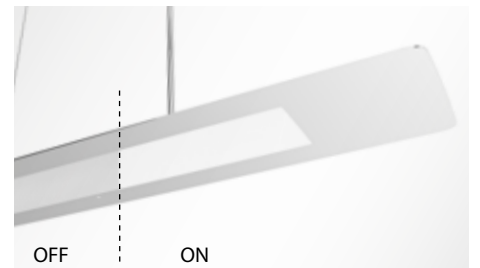

High transparent glass with a white ceramic edge (WHITE TR) and integrated micro prism for efficient light diffusion, glare minimisation, and excellent uniformity

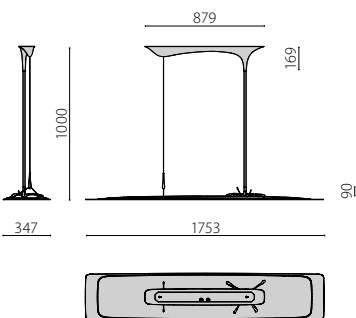

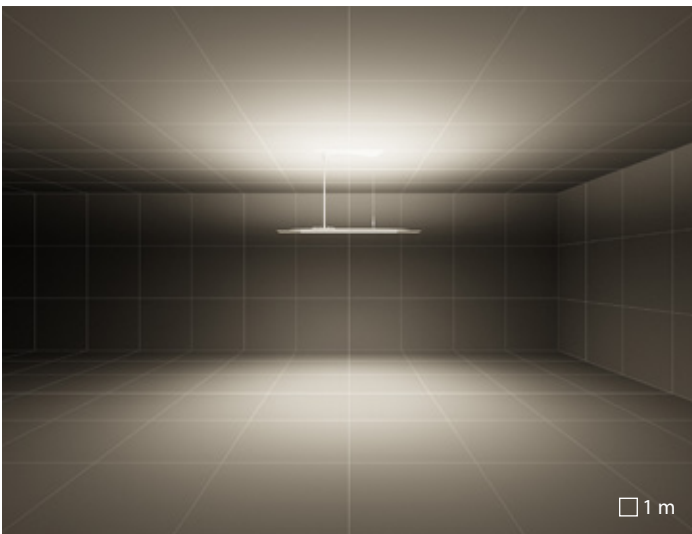

S/D symmetric mainly indirect lighting



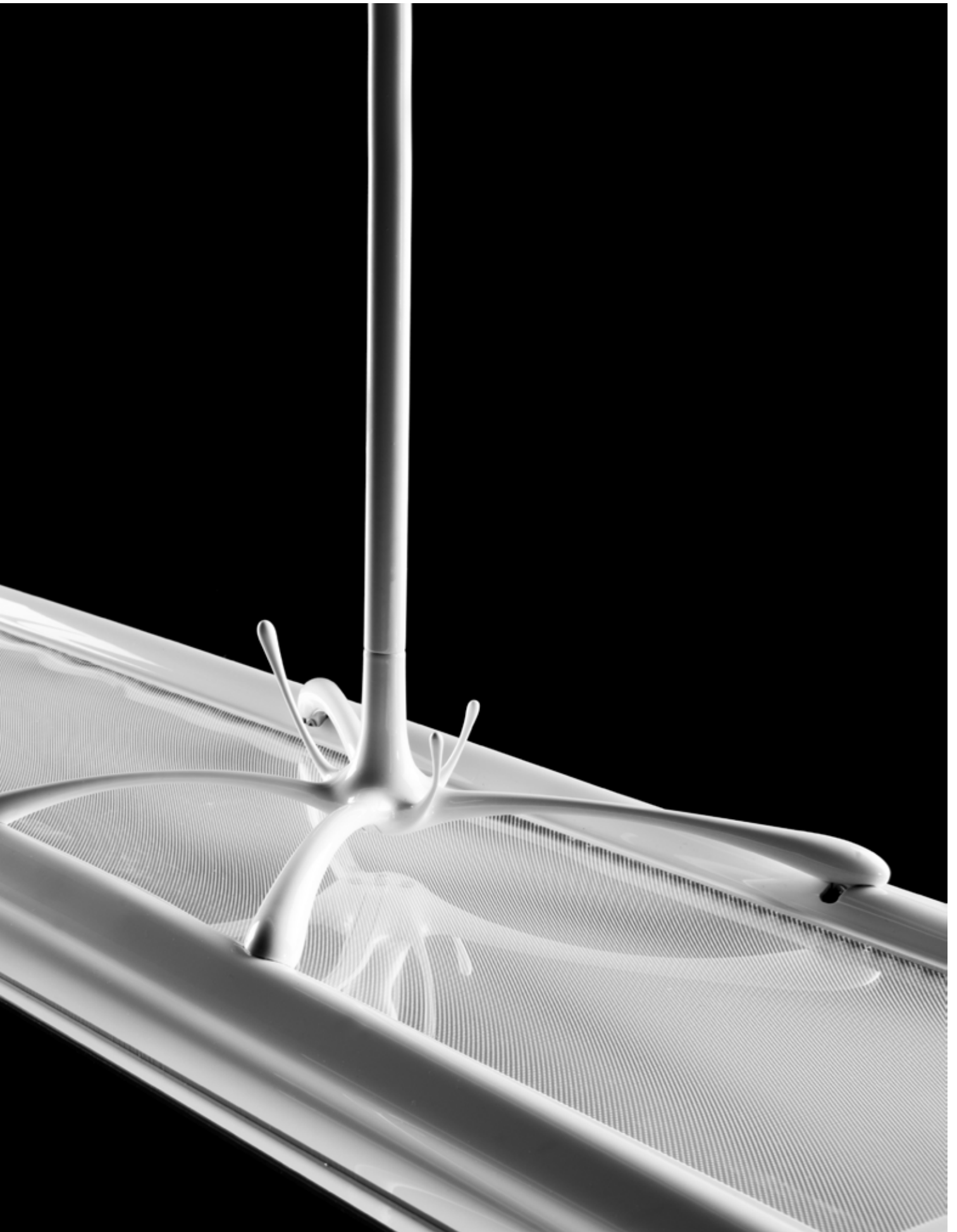

# MERCURY

design Walter de Silva

## Solid Waves

Roundness and voluptuousness. MERCURY, designed by Walter de Silva for PERFORMANCE IN LIGHTING, wraps light with its enveloping volumes. A technical revolution about the hot side of light. A durable metal soul emphasises a futuristic taste that interprets the needs of the digital age. A thin outer shell, slender, seemingly delicate, hides within it the most vibrant reflections of light.

Solid Waves: Solidity in term of durability and statics as a metal balanced with dynamism given by the transient of waves are the two concepts behind this new series. Light is energy, is a wave, is evanescent. Metal is static, is durable, is forever.

Design something evanescent with a metal shape means represents something with a solid material means to catch the moment, to freeze the moment. Compact, sculptural and attractive: this new series magnifies the beauty of the material reflections.







# MERCURY

Suspended, LED luminaire for indoor, comprising:

## Construction

- Luminaire head made from glass with moulded designer cover in a wave shape and moulded technopolymer moulded canopy
- LED Sidelight-Technology for a homogenous light distribution over the entire area of the cover
- High transparent glass with a white ceramic edge (WHITE TR) and integrated micro prism for efficient light diffusion, glare minimisation, and excellent uniformity
- High transparent glass with a black ceramic edge (BLACK TR) and integrated micro prism diffuser for efficient light diffusion, glare minimisation, and excellent uniformity
- Partially mirrored, black glass with a black ceramic edge (BLACK DRK) and integrated micro prism for efficient light diffusion, glare minimisation, and excellent uniformity
- Pendant tube made from metal and cable suspension on one side

## Electrical

- Dimmable via TouchDIM®
- Colour tolerance according to MacAdam  $\leq 3$  SDCM

## Variants

- Special colour versions available. Consult factory

## Listings

- CE
- EAC
- ENEC
- Compliant to DIN EN 12464-1 (VDU)
- Made in Germany

## Warranty

- 5-year limited warranty. Complete warranty terms located at [www.performanceinlighting.com](http://www.performanceinlighting.com)
- Registered design ®





MERCURY

**CONSTRUCTION**

IP	IP20
IK	IK04 0,50J xx3
Dimensions (mm)	1753 x 347 x 1000 mm
Weight	Max 14 kg
Colour	● ●

**INSTALLATION**

Continuous mounted luminaire	-
------------------------------	---

**LED**

Lightsource lumen output	3000 K	6110 lm ÷ 13100 lm
	4000 K	6300 lm ÷ 13500 lm
Luminaire lumen output	3000 K	1850 lm ÷ 3600 lm
	4000 K	1910 lm ÷ 3710 lm
CCT - Correlated Color Temperature	3000 K - 4000 K	
CRI / SDCM (macadam step)	80/3	
Lifetime	L80B10@50000h	

**OPTIC**

S/A symmetric direct lighting	S/A 2 x 46°/45° ÷ 2 x 43°
UFF (Upward Flux Fraction)	0 %
DFF (Downward Flux Fraction)	100 %

**ELECTRICAL**

Wattage	34 W - 95 W
Class	I
EEL	A1 - A2
Ta MAX° luminarie	40°
Ta MIN° luminarie	10°
Dimmable DALI	✓
Emergency	-
COSφ ≥ 0,9	✓

**CONTROL SYSTEMS**

Infrared motion sensor - IR	-
-----------------------------	---

**STANDARDS**

EN 12464-1	✓
------------	---



# MERCURY PL



Flowing forms create a dynamically vibrant sculptural effect that remains suspended in time

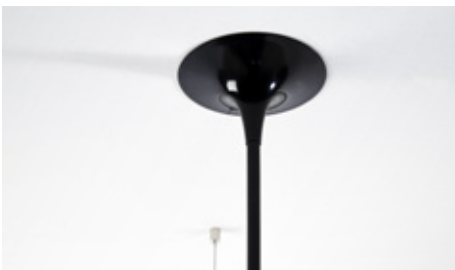

Luminaire head made from glass with moulded designer cover in a wave shape and moulded technopolymer moulded canopy



Sensor device available with task oriented PIR detector and daylight control upon request



Suitable for use in a computer environment in accordance with DIN EN 12464-1.

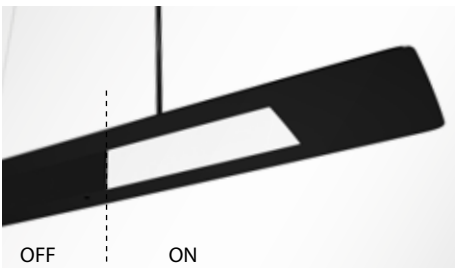

Partially mirrored, black glass with a black ceramic edge (BLACK DRK) and integrated micro prism for efficient light diffusion, glare minimisation, and excellent uniformity

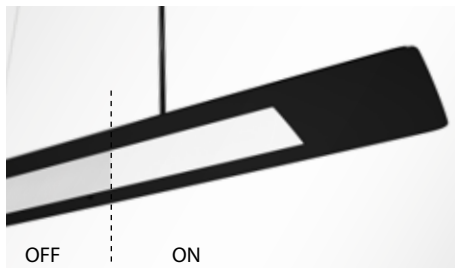

High transparent glass with a black ceramic edge (BLACK TR) and integrated micro prism diffuser for efficient light diffusion, glare minimisation, and excellent uniformity

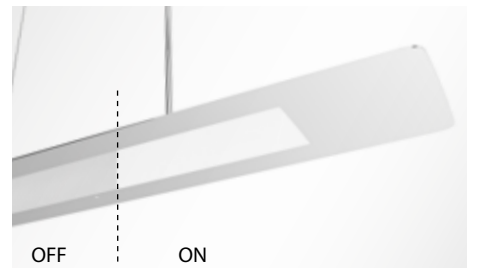

High transparent glass with a white ceramic edge (WHITE TR) and integrated micro prism for efficient light diffusion, glare minimisation, and excellent uniformity

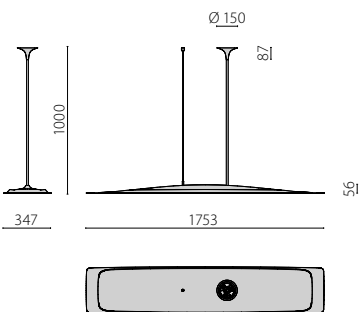

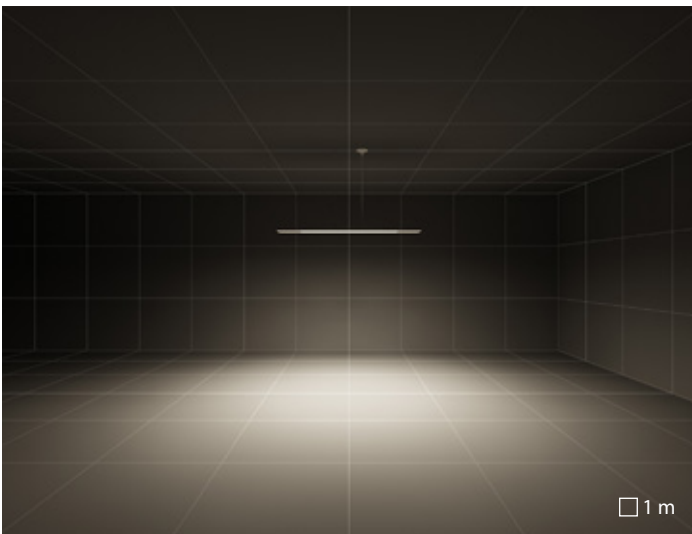

S/A symmetric direct lighting







**LIQUID**  
design Walter de Silva

## Solid Waves

Motion, energy and light. LIQUID is the first luminaire designed by Walter de Silva for PERFORMANCE IN LIGHTING where technology and beauty come together in a unique design. A distillation of pure technological essence which explores reflections on the nature of light with aesthetic values of the highest quality. Light is energy, wave, evanescence. Metal is static and durable over time. The waves of a drop crystallise into a lightweight, substantial volume that expresses fluidity and dynamism at the same time.

Solid Waves: Solidity in term of durability and statics as a metal balanced with dynamism given by the transient of waves are the two concepts behind this new series. Light is energy, is a wave, is evanescent. Metal is static, is durable, is forever.

Looks like metal, a solid material that liquefies to communicate what is inside: motion, energy and light. The formal choice of the designer magnifies the beauty of the material reflections; the result is a realistic approach with deep thin multiple waves with no line visible.





Vetroin offices | Brescia | Italy

# LIQUID

Suspended, round LED luminaire for indoor, comprising:

## Construction

- Die-cast aluminium luminaire body and canopy, powder-coated or with exclusive water lacquering painting process
- LED Sidelight-Technology for a homogenous light distribution over the entire area of the cover
- Optical diffuser with integrated high transmittance light guide in black glass (BLACK)
- Optical diffuser with integrated high transmittance light guide in shiny opal white glass (WHITE)

## Electrical

- Dimmable via TouchDIM®
- Colour tolerance according to MacAdam  $\leq 3$  SDCM

## Installation

- Consult factory for track mounting h 300 / 500 mm options.

## Variants

- Special colour versions available. Consult factory

## Listings

- CE
- EAC
- ENEC
- Made in Germany

## Warranty

- 5-year limited warranty. Complete warranty terms located at [www.performanceinlighting.com](http://www.performanceinlighting.com)
- Registered design ®





## LIQUID

**CONSTRUCTION**

IP	IP20
IK	IK02 0.20J xx0
Dimensions (mm)	1753 x 347 x 1000 mm
Weight	Max 7,7 kg
Colour	●●●○

**INSTALLATION**

Continuos mounted luminaire

-

**LED**

Lightsource lumen output	3000 K	6200 lm
Luminaire lumen output	3000 K	1020 lm ÷ 4130 lm
CCT - Correlated Color Temperature		3000 K
CRI / SDCM (macadam step)		80/3
Lifetime		L80B10@50000h

**OPTIC**

C/EW extra wide circle reflector	C/EW 2 x 46° ÷ 2 x 57°/58°
UFF (Upward Flux Fraction)	0 %
DFF (Downward Flux Fraction)	100 %

**ELECTRICAL**

Wattage	55 W
Class	I
EEL	A1 - A2
Ta MAX° luminaire	40°
Ta MIN° luminaire	10°
Dimmable DALI	✓
Emergency	-
COSφ ≥ 0,9	✓

**STANDARDS**

EN 12464-1

-



Vetroin offices | Brescia | Italy







Private house | Verona | Italy

## LIQUID PL

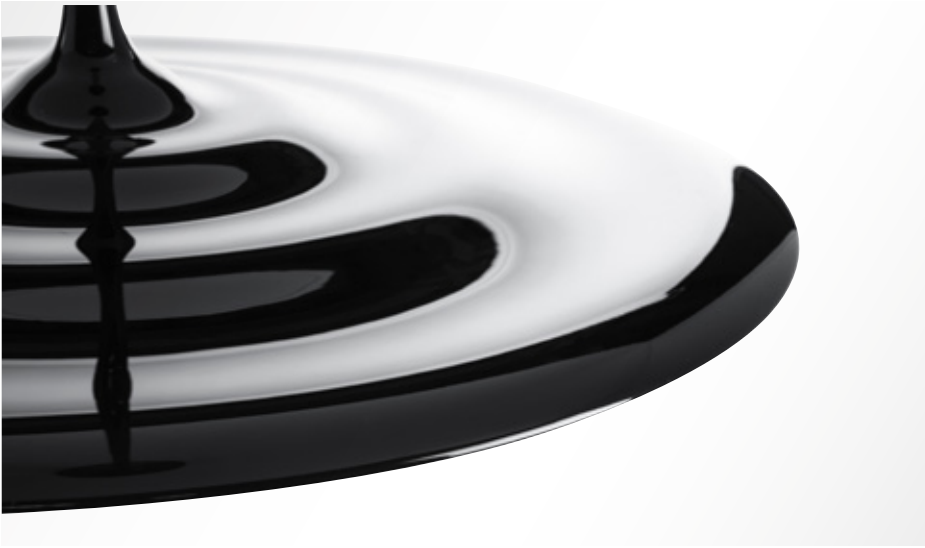

Flowing forms create a dynamically vibrant sculptural effect that remains suspended in time



Optical diffuser with integrated high transmittance light guide in shiny opal white glass (WHITE)

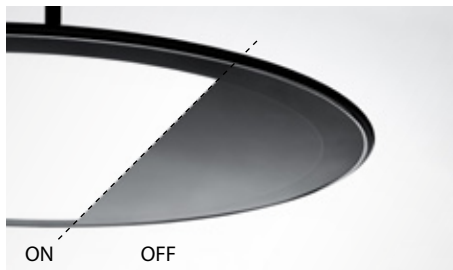

Optical diffuser with integrated high transmittance light guide in black glass (BLACK)

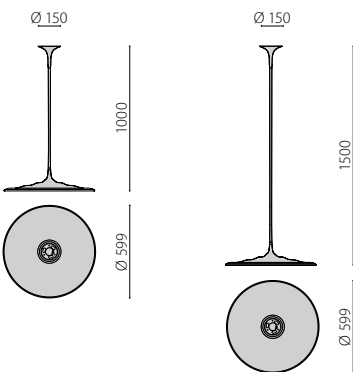



Vetroin offices | Brescia | Italy

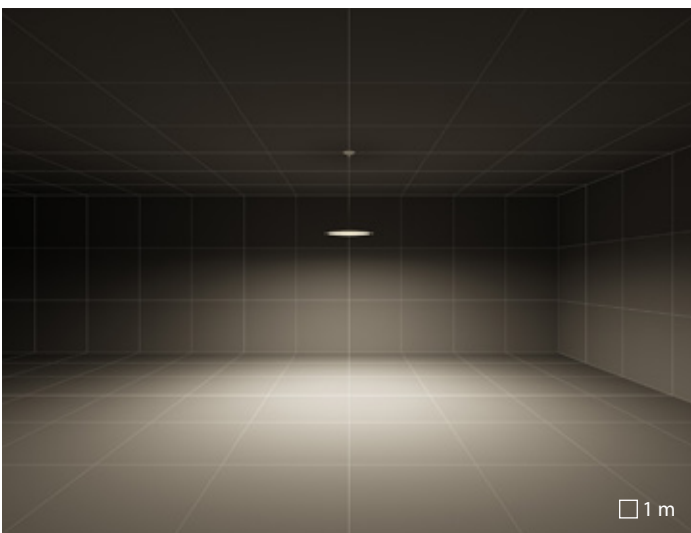

C/EW extra wide circle reflector

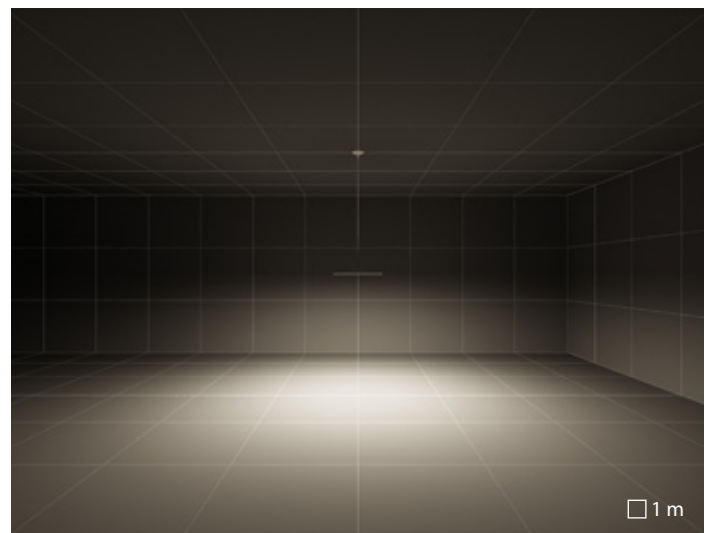

C/EW extra wide circle reflector





# SL629

Redeemed in next  
to no time

Our SL629 series make conversion worth your while. Are your old power-hungry lamps outdated and do you want to save money using more efficient lighting solutions? Nothing could be easier with the SL629. High-efficiency LEDs combined with innovative prismatic diffusers result in impressive energy savings of up to 90% without compromising on outstanding and glare-free light quality. Installing the luminaires is quick and intuitive and the separate LED module can be easily replaced at a later time if needed. All this makes the SL629 a true "future proof" solution.. The simple design suits any room, whether using the surface-mounted or suspended version. Use our LIGHT-PERFORMER® to conveniently configure your custom strip lighting system.





Offices "Haus der Höfe" | Bonn | Germany

# SL629

Design-coordinated suspended (PL) and surface mounted (AB) series. Fixtures consist of:

## Construction

- Housing made of steel sheet, die-cast aluminium end caps, powder painted
- Steel sheet canopy, painted
- Prismatic cover for efficient light diffusion, glare reduction and a high level of uniformity.
- Light engine can be replaced by means of a slide-in mechanism
- Complete with steel suspension cable (1.5 m), transparent power cord and ceiling rose

## Electrical

- Colour rendering index Ra > 80
- Colour tolerance according to MacAdam  $\leq 3$  SDCM
- LED Sidelight-Technology for a homogenous light distribution over the entire area of the cover
- Intelligent lighting control systems (daylight sensor and DALI) available
- Dimmable via TouchDIM®

## Variants

- The configurable CM version allows for individual lighting solutions
- Different connection kits available for the CM version
- Special colour versions available upon request
- Colour rendering index Ra > 90 options available. Consult factory

## Listings

- Made in Germany
- Compliant to DIN EN 12464-1 (VDU)
- ENEC
- CE
- EAC
- RCM

## Warranty

- 5-year limited warranty.  
Complete warranty terms located at [www.performanceinlighting.com](http://www.performanceinlighting.com)







		SL629 PL	SL629 PL CM	SL629 AB
<b>CONSTRUCTION</b>				
IP		IP 20	IP 20	IP 20
IK		IK05 0.70J xx3	IK05 0.70J xx3	IK05 0.70J xx3
Dimensions (mm)		1244/1544 x 273 x 29	1238/1538 x 273 x 29	1244/1544 x 273 x 50
Weight		Max 6 kg	Max 6 kg	Max 6 kg
Colour		○●	○●	○●
<b>INSTALLATION</b>				
Continuous mounted luminaire		-	✓	-
<b>LED</b>				
Lightsource lumen output	3000 K	4560 lm ÷ 11640 lm	4560 lm ÷ 11640 lm	4560 lm ÷ 11640 lm
	4000 K	4700 lm ÷ 12000 lm	4700 lm ÷ 12000 lm	4700 lm ÷ 12000 lm
Luminaire lumen output	3000 K	3040 lm ÷ 8160 lm	3040 lm ÷ 8160 lm	3040 lm ÷ 7650 lm
	4000 K	3140 lm ÷ 8410 lm	3140 lm ÷ 8410 lm	3140 lm ÷ 7880 lm
CCT - Correlated Color Temperature		3000 K / 4000 K	3000 K / 4000 K	3000 K / 4000 K
CRI / SDCM (macadam step)		80/3	80/3	80/3
		90/3	90/3	90/3
Lifetime		L80B10@50000h	L80B10@50000h	L80B10@50000h
<b>OPTIC</b>				
S/C – symmetric uniform direct-indirect light		S/C 2x41°/52° ÷ 2x42°/52°	S/C 2x41°/52° ÷ 2x42°/52°	-
S/A – symmetric direct lighting		S/A 2x36°/45° ÷ 2x36°/46°	S/A 2x36°/45° ÷ 2x36°/46°	S/A 2x36°/45° ÷ 2x37°/46°
UFF (Upward Flux Fraction)		0 % - 60 %	0 % - 60 %	0 %
DFF (Downward Flux Fraction)		100 % - 40 %	100 % - 40 %	100 %
<b>ELECTRICAL</b>				
Wattage		26 W - 31 W - 54 W - 69 W	26 W - 31 W - 54 W - 69 W	26 W - 31 W - 54 W - 69 W
Class		I	I	I
EEL		A1 - A2	A1 - A2	A1 - A2
Dimmable DALI		✓	✓	✓
COSφ ≥ 0,9		✓	✓	✓
<b>CONTROL SYSTEMS</b>				
Infrared motion sensor - IR				
<b>STANDARDS</b>				
		on request	on request	on request
DIN EN 12464-1		✓	✓	✓



Offices "Haus der Höfe" | Bonn | Germany

SL629 PL / PL CM / AB

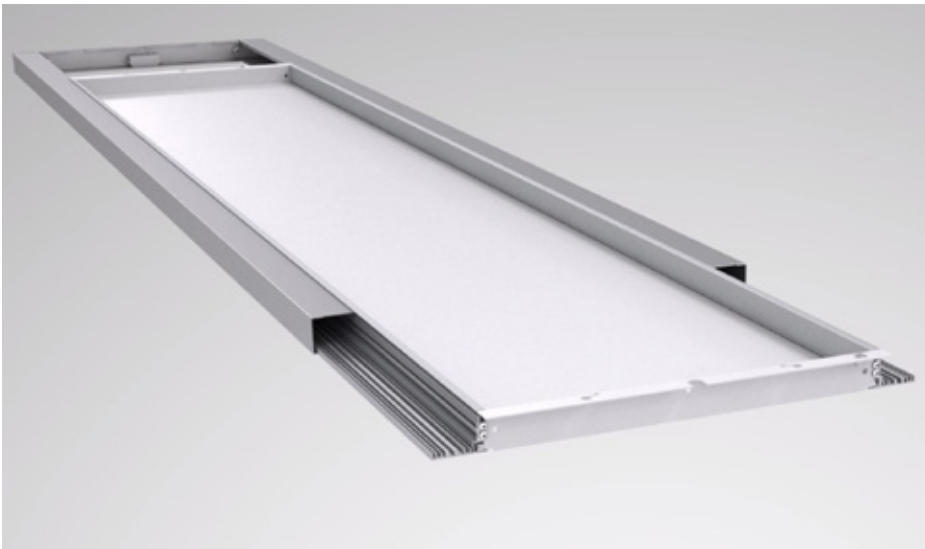

Retrofitted LED modules allow for easy, cost-efficient maintenance and make the suspended lights and surface-mounted luminaires in our SL629 series a lighting solution that is fit for the future.

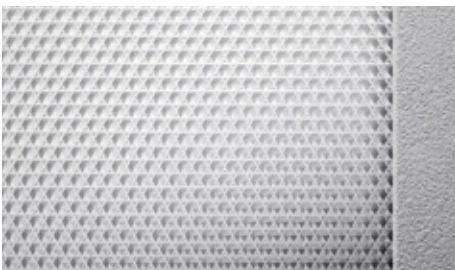

The innovative microprism combined with proven sidelight technology ensures outstanding visual comfort and glare-free light in the workplace.



The configurable CM version allows for individual lighting solutions



Modernisation work – this LED lighting series is especially suitable for 1:1 replacement of T5/T8 luminaires



Sensor device available with task oriented PIR detector and daylight control upon request



Surface-mounted version



Suitable for use in a computer environment in accordance with DIN EN 12464-1.

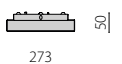
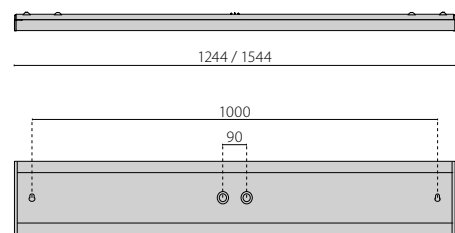
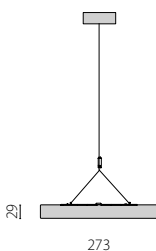
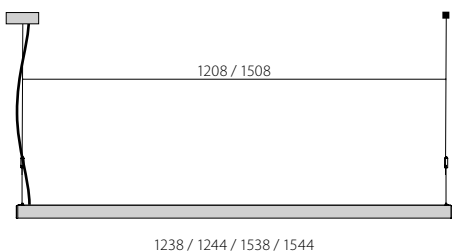

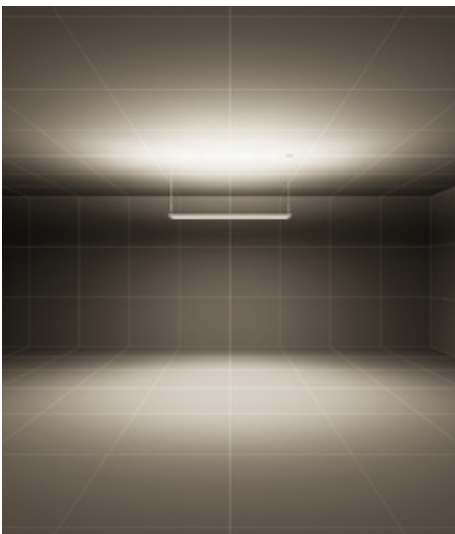

S/C – symmetric uniform direct-indirect light

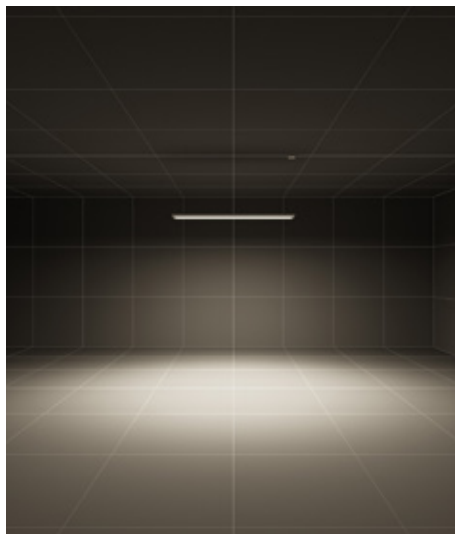

S/A – symmetric direct lighting

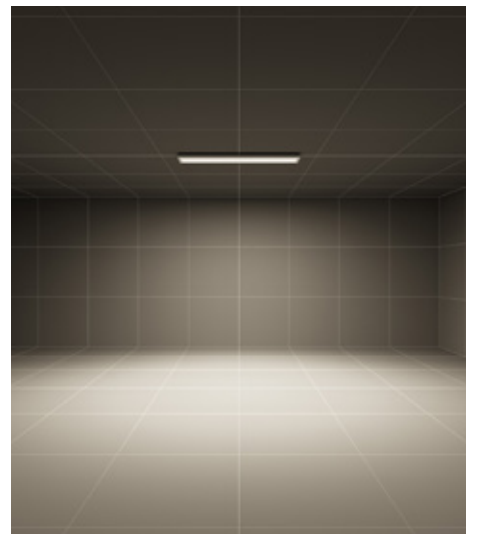

S/A – symmetric direct lighting

# SL630

## The clever LED solution for renovations

With our SL630 surface-mounted luminaire there is no need to settle for compromise in renovation contests. Do you want to replace your old T5/T8 luminaires with modern LED technology whilst minimising the expense of installation, ceiling renovation and maintenance? The SL630 is the perfect solution for you: It can be rapidly installed thanks to its intuitive mounting system. These luminaires have the ideal dimensions for concealing battered patches of ceiling – no need for time-consuming repainting and grouting. The LED modules can be easily replaced and re-installed at a later time, if needed. The SL630 also features impressive energy efficiency: compared to conventional technologies, the SL630 will save you up to 50% in energy consumption. What's more, it can even save up to 90% if used in combination with intelligent lighting control systems, such as our daylight controllers with presence sensors. In this way, the luminaire can repay itself within a very short period.





# SL630

LED surface-mount luminaire for interior, comprising

## Construction

- Housing made of steel sheet, die-cast aluminium end caps, powder painted
- Steel sheet canopy, painted
- Prismatic cover for efficient light diffusion, glare reduction and a high level of uniformity
- Version for renovation with luminaire width of >370 mm to cover the existing holes
- Light engine can be replaced by means of a slide-in mechanism

## Electrical

- Colour rendering index Ra > 80
- Colour tolerance according to MacAdam  $\leq 3$  SDCM
- LED Sidelight-Technology for a homogenous light distribution over the entire area of the cove
- Intelligent lighting control systems (daylight sensor and DALI) available
- Dimmable via TouchDIM®

## Variants

- Special colour versions available upon request

## Listings

- Made in Germany
- Limitazione dell'abbigliamento conforme alla norma DIN EN 12464-1
- ENEC
- CE
- EAC
- RCM

## Warranty

- 5-year limited warranty.  
Complete warranty terms located at [www.performanceinlighting.com](http://www.performanceinlighting.com)



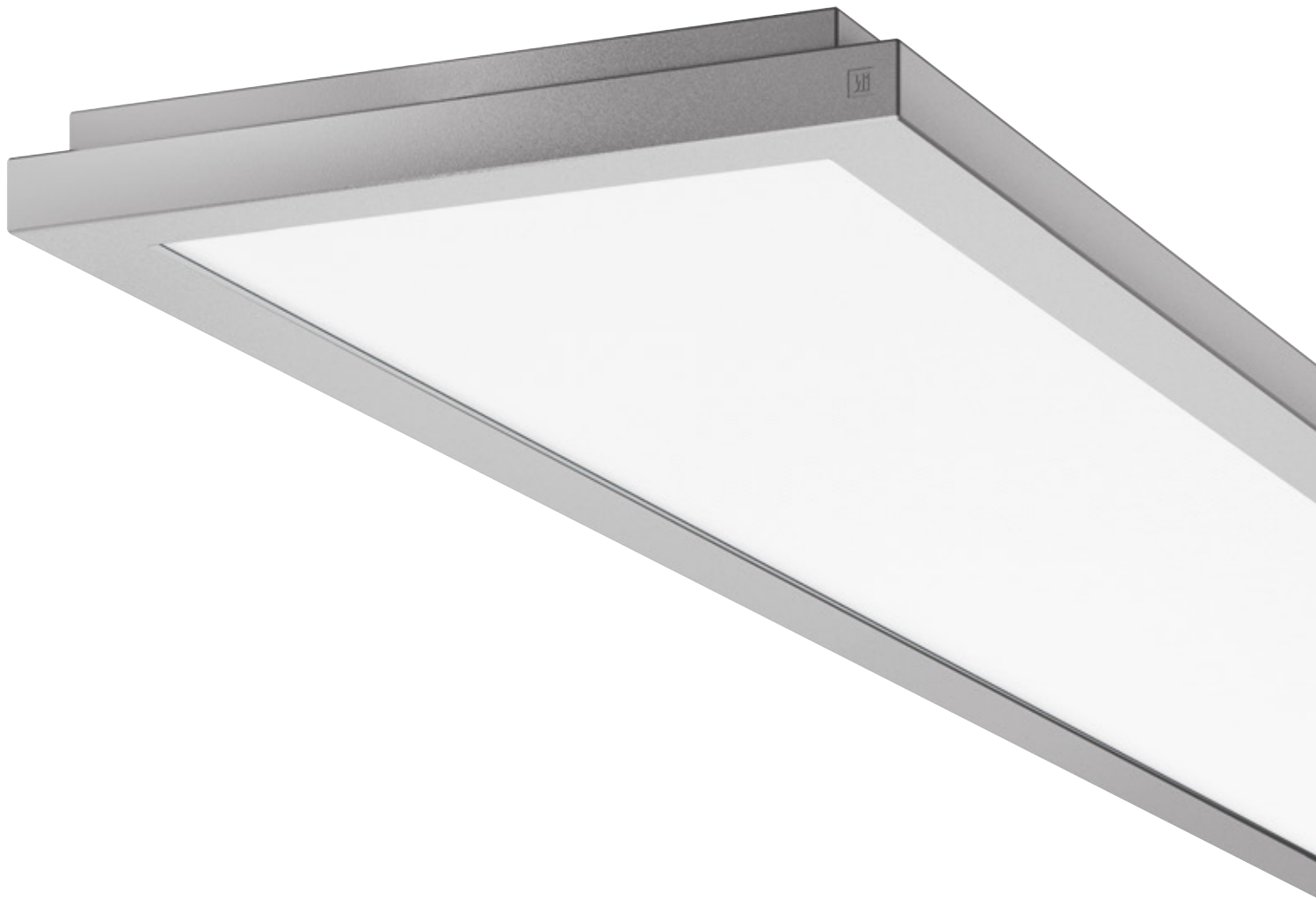



SL630 AB

<b>CONSTRUCTION</b>		
IP		IP 20
IK		IK05 0.70J xx3
Dimensions (mm)		1244/1544 x 273 x 50
Weight		Max 10 kg
Colour		○ ●
<b>INSTALLATION</b>		
Continuous mounted luminaire		-
<b>LED</b>		
Lightsource lumen output	3000 K	6980 lm ÷ 9120 lm
	4000 K	7200 lm ÷ 9400 lm
Luminaire lumen output	3000 K	4590 lm ÷ 5950 lm
	4000 K	4730 lm ÷ 6140 lm
CCT - Correlated Color Temperature		3000 K / 4000 K
CRI / SDCM (macadam step)		80/3
Lifetime		L80B10@50000h
<b>OPTIC</b>		
S/A – symmetric direct lighting		S/A 2 x 36°/46° ÷ 2 x 37°/46°
UFF (Upward Flux Fraction)		0 %
DFF (Downward Flux Fraction)		100 %
<b>ELECTRICAL</b>		
Wattage		40 W - 49 W
Class		I
EEl		A1 - A2
Dimmable DALI		✓
COSφ ≥ 0,9		✓
<b>CONTROL SYSTEMS</b>		
Infrared motion sensor - IR		on request
<b>STANDARDS</b>		
DIN EN 12464-1		✓



Zalando headquarters | Berlin | Germany

## SL630 AB



Intelligent dimensions that are specially adapted for renovating old lighting installations make additional work like filling in holes and cracks or painting ceilings unnecessary. COVER-UP! The SL630 covers almost all common linear luminaires with conventional lighting technology.

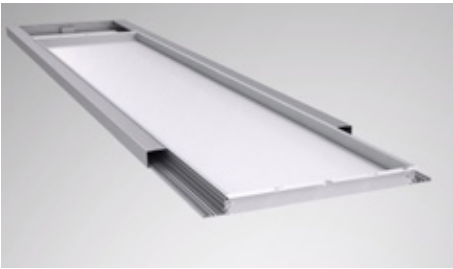

Retrofitted LED modules allow for easy, cost-efficient maintenance and make this series of luminaires a lighting solution that is fit for the future



Modernisation work – this LED lighting series is especially suitable for 1:1 replacement of T5/T8 luminaires



Sensor device available with task oriented PIR detector and daylight control upon request

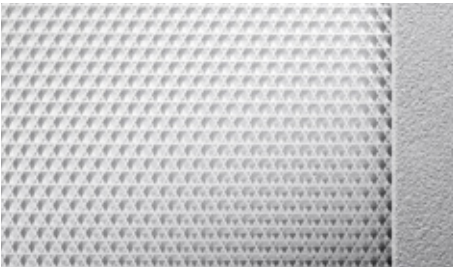

The innovative microprism combined with proven sidelight technology ensures outstanding visual comfort and glare-free light in the workplace



Suitable for use in a computer environment in accordance with DIN EN 12464-1

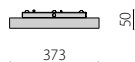
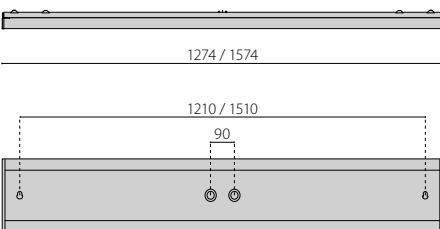

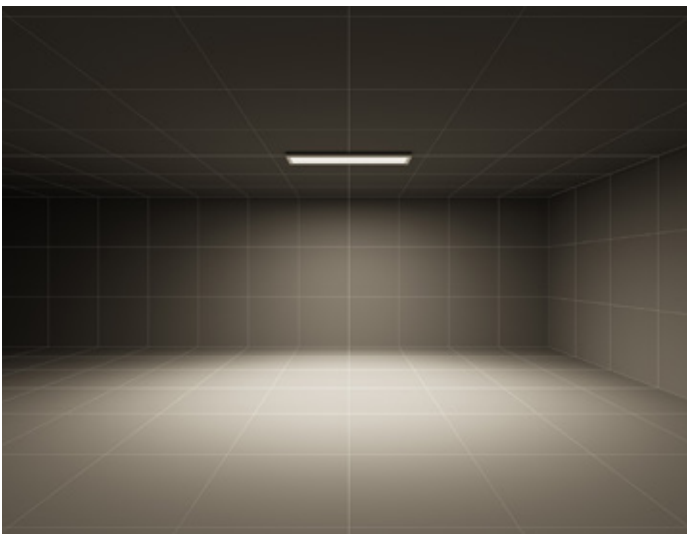

S/A – symmetric direct lighting





Zalando headquarters

# SL764+

## Infinitely versatile

At just 40 mm wide, the SL764+ is our most streamlined lighting system, but it is also the most versatile. A limited number of combinable factors create an almost infinite range of product variants. The SL764+ is a real all-rounder throughout the entire office, education and administration sector. The lighting system and the associated individual luminaires from this elegant range are characterised by a clear and linear design language that adapts aesthetically and also discreetly to any architecture. As an individual luminaire, the SL764+ creates dynamic accents and its two installation types (recessed and suspended light) provide planning flexibility. The lighting system offers maximum design freedom in terms of dimension, capacity, shapes, installation types, lighting technology and sensors and provides the option to implement a uniform photometric concept throughout the building. With our award-winning LIGHT-PERFORMER® planning tool, even complex lighting systems can be individually configured in just a few minutes.







Finstral customer centre | Goschheim | Germany

# SL764+

Design-coordinated suspended (PL), surface mounted (AB) and configurable lighting system series.  
Fixtures consist of:

## Construction

- Extruded aluminium profile housing, anodised (EV1) or powder coated
- Die-cast aluminium end caps, painted
- A range of light optics: Anti-glare micro prism (DIN EN 12464-1), black grid and opal cover for consistent light distribution
- Streamlined, simple design with flush end caps
- High-quality workmanship of profile connections for a perfect look
- Simple and convenient lighting installation
- Interchangeable lighting inserts
- Complete with steel suspension cable (1.5 m), transparent power cord and canopy (PL)

## Electrical

- Colour rendering index Ra > 80
- Colour tolerance according to MacAdam ≤ 3 SDCM
- Through-wiring design

## Variants

- Configuration of individual luminaires and lighting systems in any length, capacity and design according to your needs - with our award-winning LIGHT-PERFORMER®
- Configurable conductor rails, blind fields, sensor modules and tunable white versions
- Configurable as a suspended luminaire, surface mounted luminaire, wall mounted luminaire and recessed luminaire (frame/trimless)
- Configuration of complex lighting systems in L, S, Z, or rectangular designs provide maximum design freedom
- Special colour versions available upon request
- Colour rendering index Ra > 90 options available. Consult factory

## Listings

- Made in Germany
- Compliant to DIN EN 12464-1 (VDU)
- ENEC
- CE

## Warranty

- 5-year limited warranty.  
Complete warranty terms located at [www.performanceinlighting.com](http://www.performanceinlighting.com)



## SL764+



SL764+ PL

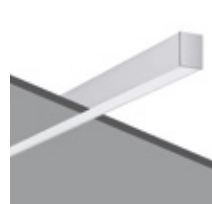

SL764+ RE



SL764+ LIGHTING SYSTEM

CONSTRUCTION				
IP		IP 30	IP 30	IP 30
IK		IK05 0.70J xx3	IK05 0.70J xx3	IK05 0.70J xx3
Dimensions (mm)		1132/1412 x 44 x 66	1132/1412 x 44 x 66	max. 25 m x 44 x 66
Weight		Max 10 kg	Max 10 kg	-
Colour		●	●	○ ● ●
INSTALLATION				
Continuous mounted luminaire		✓	✓	✓
LED				
Lightsource lumen output	3000 K	1630 lm ÷ 2040 lm	1630 lm ÷ 2040 lm	-
	4000 K	1720 lm ÷ 2150 lm	1720 lm ÷ 2150 lm	-
Luminaire lumen output	3000 K	1410 lm ÷ 1770 lm	1410 lm ÷ 1770 lm	975 lm/m ÷ 5434 lm/m
	4000 K	1490 lm ÷ 1860 lm	1490 lm ÷ 1860 lm	1024 lm/m ÷ 5545 lm/m
CCT - Correlated Color Temperature		3000 K / 4000 K	3000 K / 4000 K	3000 K / 4000 K / 2700-6200 K
CRI / SDCM (macadam step)		80/3	80/3	80/3
		90/3	90/3	90/3
Lifetime		L80B10@50000h	L80B10@50000h	L80B10@50000h
OPTIC				
S/A – symmetric direct lighting		S/A 2 x 48°/51°	S/A 2 x 48°/51°	S/A
S/C – symmetric uniform direct-indirect light		-	-	S/C
UFF (Upward Flux Fraction)		0 %	0 %	0 % - 40 % - 50 % - 75 %
DFF (Downward Flux Fraction)		100 %	100 %	100 % - 60 % - 50 % - 25 %
ELECTRICAL				
Wattage		10 W - 12 W	10 W - 12 W	9 W ÷ 51 W
Class		I	I	I
EEL		A1 - A2	A1 - A2	A1 - A2
Dimmable DALI		-	-	✓
COSφ ≥ 0,9		✓	✓	✓
CONTROL SYSTEMS				
Infrared motion sensor - IR		-	-	✓
Tunable White		-	-	✓
STANDARDS				
DIN EN 12464-1		-	-	✓



Handelskammer innovations campus | Hamburg | Germany

## SL764+ PL



Straight linear aluminium profiles with flush end caps ensure a clear, linear design language

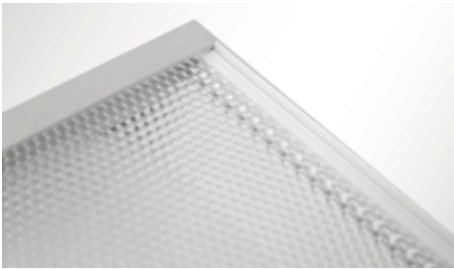

Perfect fit of the light optics thanks to expansion compensating recesses in the headpieces



Consistent light projection without visible LED dots over the entire light-emitting surface



Up to 159 lm/W thanks to highly efficient LED modules and innovative reflector technology



The ceiling distance can be adjusted easily and flexibly, using our functional cable suspension



Future-proof and maintenance-friendly thanks to replaceable LED modules and components



Planning customised lighting systems in just 5 minutes is simple with our award-winning LIGHT-PERFORMER®

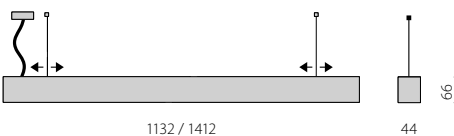



Nordex offices | Hamburg | Germany

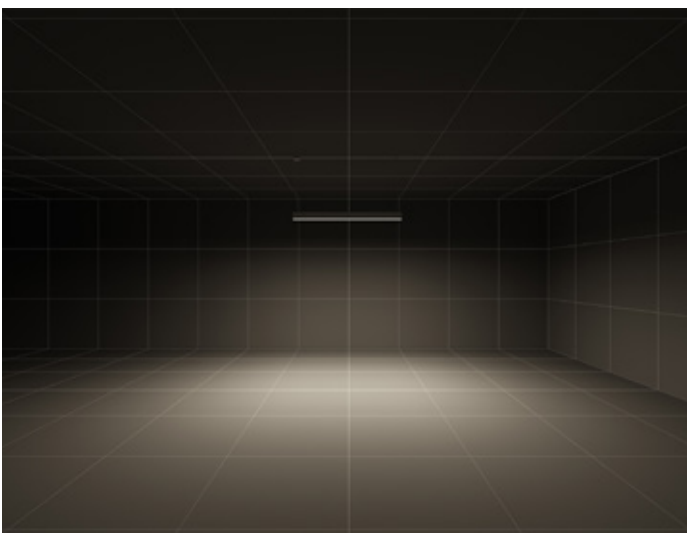

S/A – symmetric direct lighting

## SL764+ RE

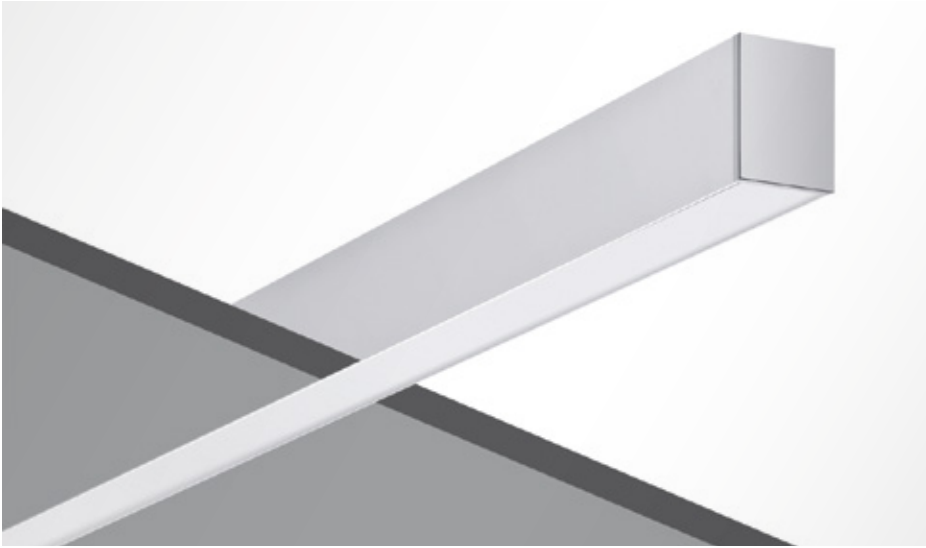

Straight linear aluminium profiles with flush end caps ensure a clear, linear design language

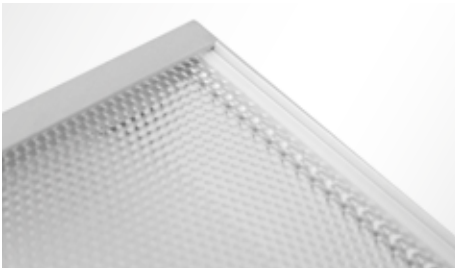

Perfect fit of the light optics thanks to expansion compensating recesses in the headpieces



Consistent light projection without visible LED dots over the entire light-emitting surface



Up to 159 lm/W thanks to highly efficient LED modules and innovative reflector technology



Intuitive and easy luminaire installation in no time thanks to intelligent „CLICK-IN“ technology



Future-proof and maintenance-friendly thanks to replaceable LED modules and components



Planning customised lighting systems in just 5 minutes is simple with our award-winning LIGHT-PERFORMER®

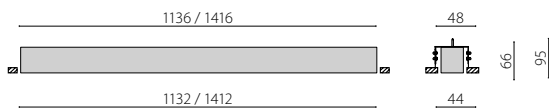





Centre for integrative psychiatry | Kiel | Germany

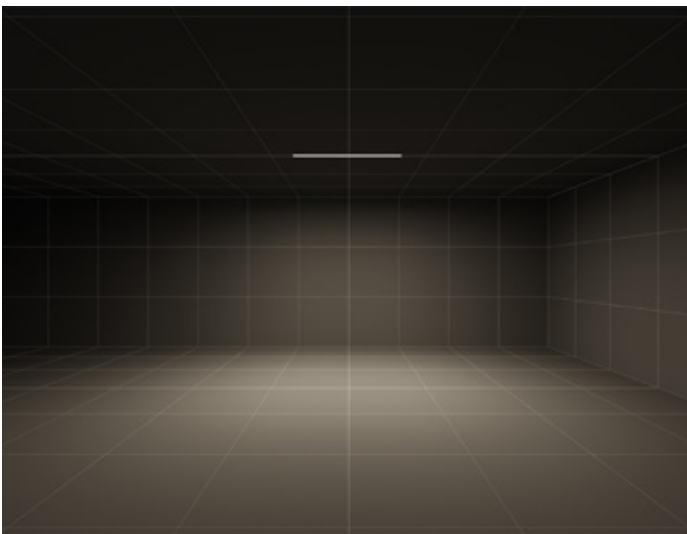

S/A – symmetric direct lighting

## SL764+ LIGHTING SYSTEM



Configuration of individual luminaires and lighting systems in any length, capacity and design according to your needs - with our award-winning LIGHT-PERFORMER®

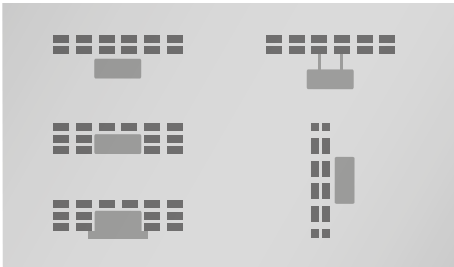

Configurable as a suspended luminaire, surface mounted luminaire, wall mounted luminaire and recessed luminaire (frame/trimless)

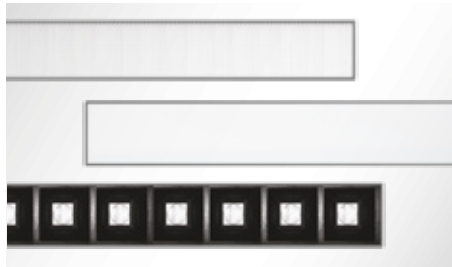

A range of light optics: Anti-glare micro prism (DIN EN 12464-1), black grid and opal cover for consistent light distribution



Configuration of complex lighting systems in L, S, Z, or rectangular designs provide maximum design freedom



Striplights without optical interruptions possible up to a length of 25 m



The corners of the system are 100% illuminated, both directly and indirectly



Intuitive and easy luminaire installation in no time thanks to intelligent „CLICK-IN“ technology

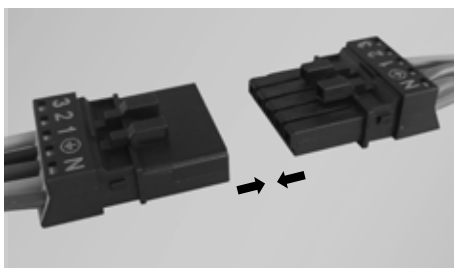

Simple electrical connection using through wiring via Plug & Play



Future-proof and maintenance-friendly thanks to replaceable LED modules and components



Mediateque les 7 lieux | Bayeux | France



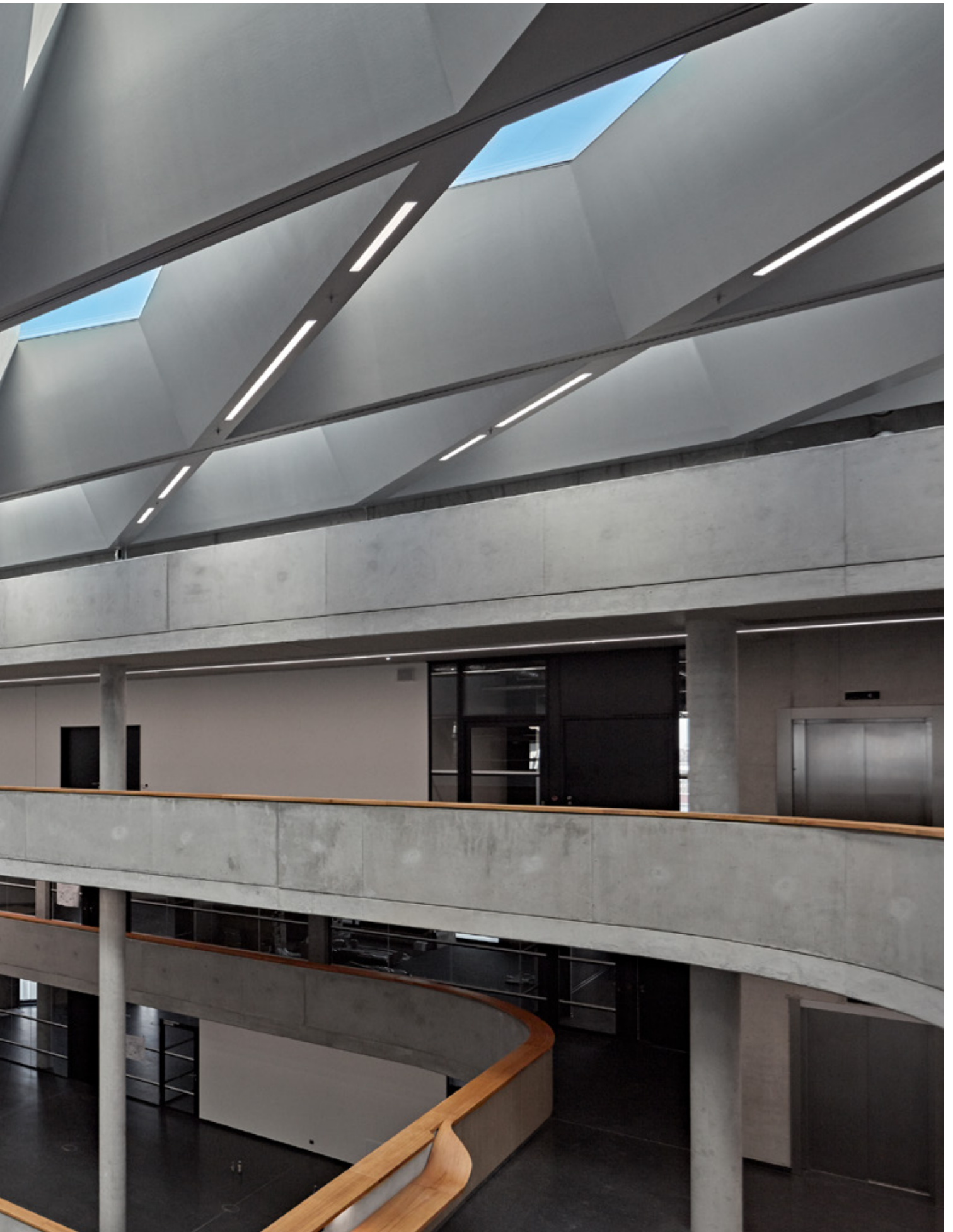

Zalando headquarters | Berlin | Germany

# SL787+

## Myriad possibilities

Lighting systems are used to showcase and accentuate the architecture, but also to add structure to certain areas. Due to the mostly very individual and complex requirements for intelligent, versatile and energy-efficient lighting systems, their planning and installation is often very demanding and time-consuming. Here, our SL787+ lighting system provides tailor-made solutions. The lighting system and the associated individual luminaires offer maximum design freedom thanks to a range of dimensions, wattages, shapes, installation types and lighting technology and give you the opportunity to implement a uniform photometric concept throughout the building. With our award-winning LIGHT-PERFORMER® planning tool, even complex lighting systems can be individually configured in just a few minutes.





OFFICES COMPENSORIO OLIVETTI | Naples | Italy

# SL787+

Design-coordinated suspended (PL), surface mounted (AB) and configurable lighting system series.  
Fixtures consist of:

## Construction

- Extruded aluminium profile housing, anodised (EV1) or powder coated
- Die-cast aluminium end caps, painted
- A range of light optics: Anti-glare micro prism (DIN EN 12464-1) and opal cover for consistent light distribution
- Streamlined, simple design with flush end caps
- High-quality workmanship of profile connections for a perfect look
- Simple and convenient lighting installation
- Interchangeable lighting inserts
- Complete with steel suspension cable (1.5 m), transparent power cord and canopy (PL)

## Electrical

- Colour rendering index Ra > 80
- Colour tolerance according to MacAdam ≤ 3 SDCM
- Through-wiring design

## Variants

- Configuration of individual luminaires and lighting systems in any length, capacity and design according to your needs - with our award-winning LIGHT-PERFORMER®
- Configurable conductor rails, blind fields, sensor modules and tunable white versions
- Configurable as a suspended luminaire, surface mounted luminaire, wall mounted luminaire and recessed luminaire (frame/trimless)
- Configuration of complex lighting systems in L, S, Z, or rectangular designs provide maximum design freedom
- Special colour versions available upon request
- Colour rendering index Ra > 90 options available. Consult factory

## Listings

- Made in Germany
- Compliant to DIN EN 12464-1 (VDU)
- ENEC
- CE

## Warranty

- 5-year limited warranty.  
Complete warranty terms located at [www.performanceinlighting.com](http://www.performanceinlighting.com)





## SL787+



SL787+ PL

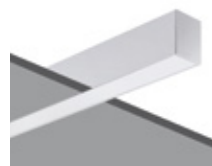

SL787+ RE



SL787+ LIGHTING SYSTEM

<b>CONSTRUCTION</b>				
IP		IP 30	IP 30	IP 30
IK		IK05 0.70J xx3	IK05 0.70J xx3	IK05 0.70J xx3
Dimensions (mm)		1132/1412 x 70 x 85	1132/1412 x 70 x 85	max. 25 m x 70 x 85
Weight		Max 10 kg	Max 10 kg	-
Colour		●	●	○ ● ●
<b>INSTALLATION</b>				
Continuous mounted luminaire		✓	✓	✓
<b>LED</b>				
Lightsource lumen output	3000 K	1630 lm ÷ 2040 lm	1630 lm ÷ 2040 lm	-
	4000 K	1720 lm ÷ 2150 lm	1720 lm ÷ 2150 lm	-
Luminaire lumen output	3000 K	1450 lm ÷ 1820 lm	1450 lm ÷ 1820 lm	983 lm/m ÷ 4860 lm/m
	4000 K	1530 lm ÷ 1910 lm	1530 lm ÷ 1910 lm	1141 lm/m ÷ 5010 lm/m
CCT - Correlated Color Temperature		3000 K / 4000 K	3000 K / 4000 K	3000 K / 4000 K / 2700-6200 K
CRI / SDCM (macadam step)		80/3	80/3	80/3
		90/3	90/3	90/3
Lifetime		L80B10@50000h	L80B10@50000h	L80B10@50000h
<b>OPTIC</b>				
S/A – symmetric direct lighting		S/A 2 x 48°/51°	S/A 2 x 48°/51°	S/A
S/C – symmetric uniform direct-indirect light		-	-	S/C
UFF (Upward Flux Fraction)		0 %	0 %	0 % - 50 % - 75 %
DFF (Downward Flux Fraction)		100 %	100 %	100 % - 50 % - 25 %
<b>ELECTRICAL</b>				
Wattage		10 W - 12 W	10 W - 12 W	9 W ÷ 36 W
Class		I	I	I
EEL		A1 - A2	A1 - A2	A1 - A2
Dimmable DALI		-	-	✓
COSφ ≥ 0,9		✓	✓	✓
<b>CONTROL SYSTEMS</b>				
Infrared motion sensor - IR		-	-	✓
Tunable White		-	-	✓
<b>STANDARDS</b>				
DIN EN 12464-1		-	-	✓



Handelskammer innovations campus | Hamburg | Germany

## SL787+ PL



Straight linear aluminium profiles with flush end caps ensure a clear, linear design language

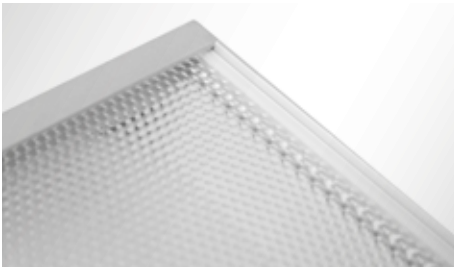

Perfect fit of the light optics thanks to expansion compensating recesses in the headpieces



Consistent light projection without visible LED dots over the entire light-emitting surface



Up to 159 lm/W thanks to highly efficient LED modules and innovative reflector technology



The ceiling distance can be adjusted easily and flexibly, using our functional cable suspension



Future-proof and maintenance-friendly thanks to replaceable LED modules and components



Planning customised lighting systems in just 5 minutes is simple with our award-winning LIGHT-PERFORMER®





Offices comprensorio Olivetti | Naples | Italy

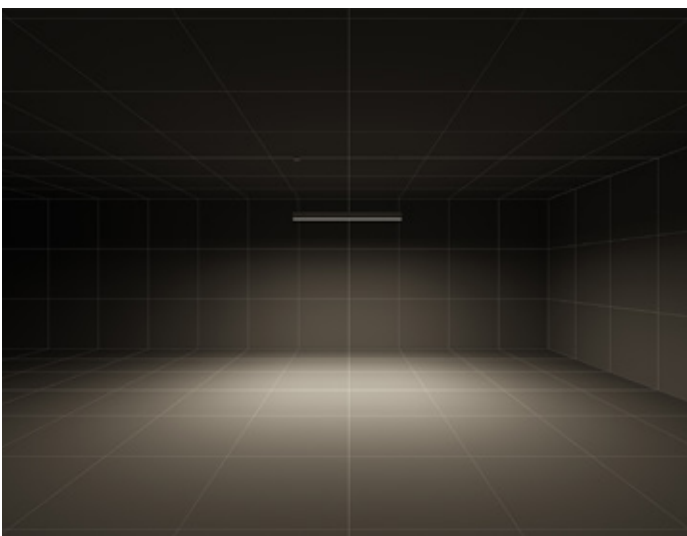

S/A – symmetric direct lighting

## SL787+ RE



Straight linear aluminium profiles with flush end caps ensure a clear, linear design language

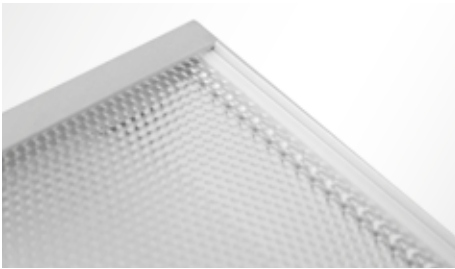

Perfect fit of the light optics thanks to expansion compensating recesses in the headpieces



Consistent light projection without visible LED dots over the entire light-emitting surface



Up to 159 lm/W thanks to highly efficient LED modules and innovative reflector technology



Intuitive and easy luminaire installation in no time thanks to intelligent „CLICK-IN“ technology



Future-proof and maintenance-friendly thanks to replaceable LED modules and components



Planning customised lighting systems in just 5 minutes is simple with our award-winning LIGHT-PERFORMER®

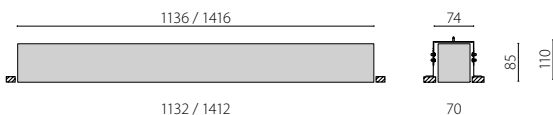



Adigeo shopping centre | Verona | Italy

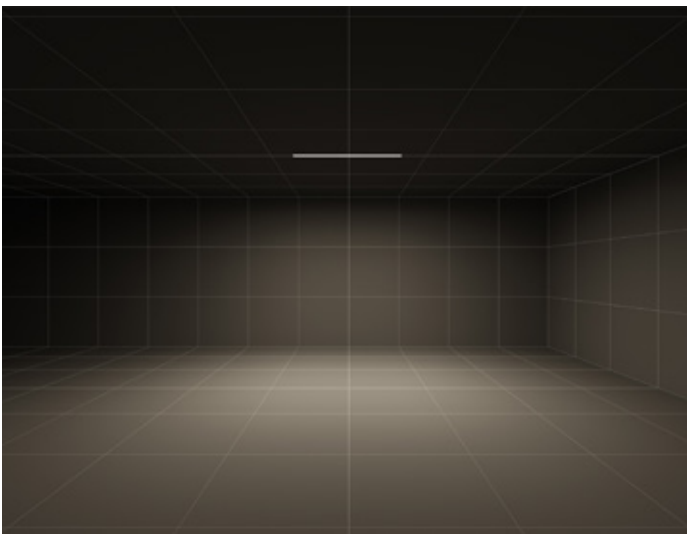

S/A – symmetric direct lighting

## SL787+ LIGHTING SYSTEM



Configuration of individual luminaires and lighting systems in any length, capacity and design according to your needs - with our award-winning LIGHT-PERFORMER®

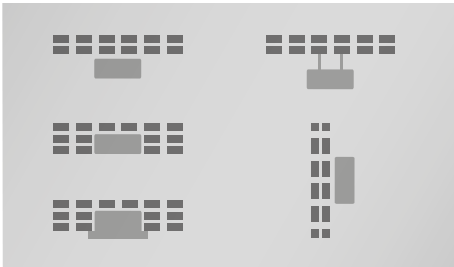

Configurable as a suspended luminaire, surface mounted luminaire, wall mounted luminaire and recessed luminaire (frame/trimless)



A range of light optics: Anti-glare micro prism (DIN EN 12464-1) and opal cover for consistent light distribution



Configuration of complex lighting systems in L, S, Z, or rectangular designs provide maximum design freedom



Striplights without optical interruptions possible up to a length of 25 m



The corners of the system are 100% illuminated, both directly and indirectly

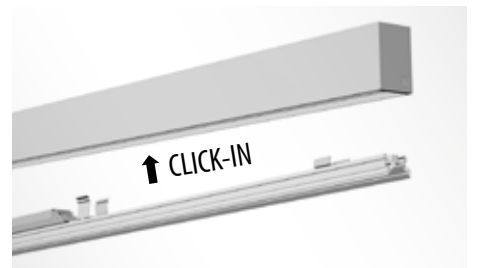

Intuitive and easy luminaire installation in no time thanks to intelligent „CLICK-IN“ technology

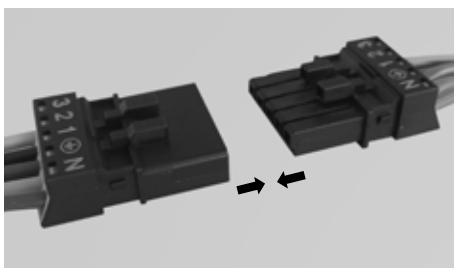

Simple electrical connection using through wiring via Plug & Play



Future-proof and maintenance-friendly thanks to replaceable LED modules and components





Bethanien hospital | Moers | Germany



# SAVE ENERGY

Energy savings from requirement-based lighting control systems



In analyzing the lifecycle of a luminaire, we know that almost 90% of the energy it necessitates is used in operation; this clearly illustrates the extent of the potential energy and cost savings achievable for users. Old luminaires and static light switches are still in place in many existing installations, where regular luminaire failures and high power consumption give rise to unnecessarily high operating and maintenance costs. Energy savings of 50% can be made simply by switching to advanced LED technology; the potential savings from using dimmable ballasts in combination with a lighting control system are even greater. This arrangement permits the

provision of light just as required: the right light at the right time, in the right place and at the right level. Through the use of corresponding sensors on lights or in the room, the light can adapt to requirements, the time of day and whether or not employees are present. Investing in refurbishments that include a lighting control system generally pays off within a few years. This is because the material and maintenance costs that arise from the regular replacement of old and broken bulbs alone are eliminated, and also because old lamps often consume many times more power than modern, high-efficiency LED luminaires. Putting a lighting control system in

place creates a winning outcome: lower operating costs and higher light quality, which in turn increases employee satisfaction. We have developed LIGHT-PERFORMER® so you can identify the ideal renovation solution for you and determine the associated potential energy saving. Learn more on page 142 or at [www.light-performer.com](http://www.light-performer.com)



# HUMAN CENTRIC LIGHTING

Lighting to make you feel good

From early humanity, we evolved in the open air under the natural light of the sun. As we evolved, our biorhythms adapted to the dynamic changes in daylight, which is why light color and intensity now control our hormonal balance, regulating whether we become tired and go to sleep, or feel wide awake and full of beans – it all depends on the rhythms of daylight. Today, everyday office life often includes only a tiny amount of daylight, which is why HCL lighting concepts seek to reintroduce a little piece of nature.



A lighting control system simulates the natural dynamics of daylight in terms of light intensity, color temperature and light direction, producing appropriately stimulating light depending on the time of day – motivating or relaxing. This stabilizes our circadian rhythm so that we can remain productive throughout the day and enjoy restful sleep at night. The DIN SPEC 67600 specification sets out recommendations for how this stimulating light should be scheduled:

**Between 8 am and 10 am:**

Light should have an activating effect to enable us to start the day alert (8000 K and a vertical light intensity of 250 lx to the eye).

**Between 13 am and 14 am:**

Lighting should have an invigorating effect during lunch break to prevent an afternoon slump.

**Between 18 am and 20 am:**

After work has finished, warm light helps us to relax (3000 K and a vertical light intensity of 200 lx to the eye). Between these times, the light intensity and light color should be selected to suit the activity taking place.

# HUMAN CENTRIC LIGHTING

## CIRCADIAN RHYTHM

Light affects us. Our productivity is particularly high during the morning period, increasing right up until lunchtime before levelling out and decreasing continually towards evening. These biological processes are controlled mainly by daylight, and an HCL lighting concept goes a long way towards supporting this natural process.



### PRODUCTIVITY

HCL promotes productivity and concentration in the workplace



### SYNCHRONIZATION

HCL lighting control systems align our body clocks with the natural rhythm of day and night.



### VISUAL COMFORT

Natural lighting at the right light intensity makes things easier on the eyes.



### HEALTH

HCL supports our natural biorhythms and ensures enhanced wellbeing.



## COLOR SPECTRUM

With HCL, artificial light imitates the natural color dynamics of sunlight over the course of the day.



## DESIGN

A successful lighting solution makes the surfaces and colors in a room shine. Tunable White makes it possible to adapt the color temperature of lighting specifically to suit the color concept of the interior architecture. The color rendering (Ra) of our luminaires remains stable at >80 across the entire color temperature range.



## DYNAMICS AND ATMOSPHERE

Dynamic light transforms the atmosphere in the room, keeping it adapted to the respective requirements.



## USAGE

Warm white light with a low lighting level calms us and promotes creativity, making it an especially suitable option for relaxation and recreation areas. Cold white light (> 5,000K) makes us alert and productive. It is most effective in spaces where mental and physical productivity are the top priority.



# DAYLIGHT CONTROLLER

The right light at the right time





Using available daylight is of paramount importance when planning a lighting system that is intended to simultaneously save energy and improve wellbeing. Even on a cloudy day, the light intensity of daylight is much higher than that of artificial lighting. In addition to which, daylight is available free of charge – unlike artificial light. The natural rhythm of daylight and manifold variations in brightness over the course of the day are particularly pleasurable for us as humans. When we spend most of our days inside buildings, being able to see outdoors

enables us to come into contact with weather, times and seasons. Architecture featuring well-designed glazed surfaces and a perfectly aligned daylight controller makes valuable use of all these advantages:

- In office buildings, savings of up to 90% on energy costs can be achieved using daylight controllers.
- Dynamic lighting scenarios that imitate the progression of daylight support employees' natural biorhythms.

- This ensures higher acceptance of the lighting system, an improved sense of wellbeing and better productivity.
- When coordinated correctly with the shutter controls, the room can receive sufficient light from the sun at all positions, without occupants being dazzled or the room becoming overheated.



# dimSmart!

Personalised light without limits



Even when we are in the office, individual comfort is important – which is why we set up our workspaces to suit our needs: the alignment of monitors, sitting positions and desk height can all be adjusted as needed. So why not individually adjustable lighting as well? This makes it possible to utilize it to its full potential, as well as giving workspaces a personal note: dimSmart! makes light your personalized tool. The module, which is no larger than a matchbox, is a real problem-solver. dimSmart! is simply installed in the existing DALI luminaire and can then be controlled via Bluetooth using the free app. Using the module via

app is as easy as child's play – no need for training by a system technician. You simply install the app, configure your desired lighting scenarios encompassing various parameters such as brightness and light color, then activate these scenarios at any time. You can also save various scenarios for specific days and times using the calendar and timer functions – meaning that your preferred scenario will automatically be activated when you want it. Of course we also protect your privacy with password protecting the system and its settings to prevent unauthorized access.

No need to worry about updates either – the app automatically updates itself to the latest version, so you will always be up-to-date. dimSmart! makes the light in your office a personalized tool.

# SWARM FUNCTION

## SMARTER AS A GROUP

We see it in nature: animals are often more intelligent and more productive in swarms than when they act alone. Migratory birds can travel thousands of kilometers using an energy-efficient flock formation, while fish have the best chances of surviving against much larger predators if they are in the protection of the shoal. This same bionic principle can also be applied to control technology in open-plan offices: if intelligent ballasts communicate with each other and react to their environment as a swarm, completely new, energy-saving user profiles are facilitated. In open-plan offices in particular, there is enormous potential for saving energy using a swarm function – and with minimal effort on the part of employees.

The lights communicate wirelessly wherever they detect motion within the room and adjust the brightness level accordingly. This intelligent control system means that employees need never again find themselves sitting alone in the dark, as an island of light will form automatically around them. The room remains perceptible and we feel secure.

The light adapts to the people – completely automatically.

We would be pleased to advise you on the specific user profiles that would be most beneficial for your open-plan office.

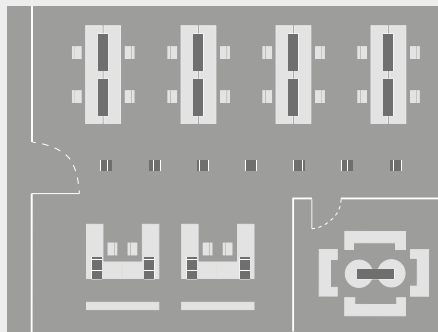

The swarm function can be used to keep lighting at a low, energy-saving level while the room is not in use (“background level”).

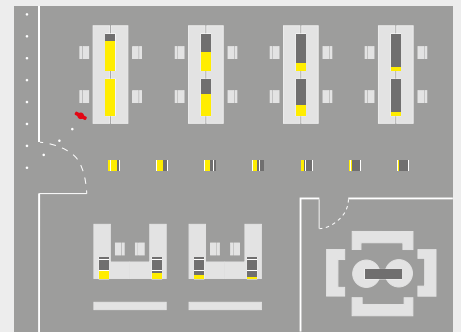

In this configuration the luminaires will only switch to full brightness around a person when they enter the room (“task level”). The surrounding luminaires continue to maintain a low-dimmed level.

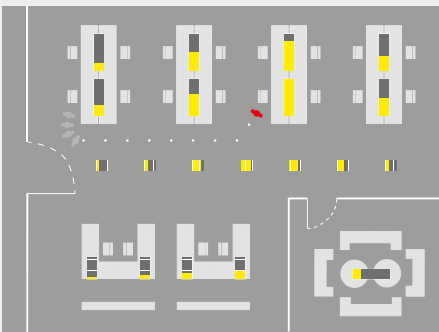

As the person moves through the room, the light follows them wherever they go. This means that only those lights that are actually being used by people are fully activated.

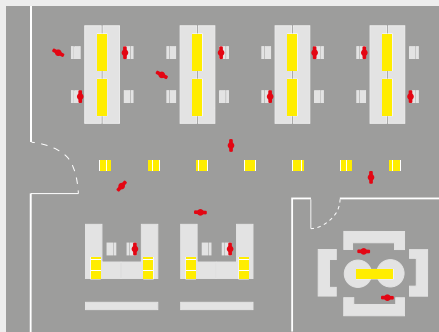

When all employees are present, the room is fully lit.

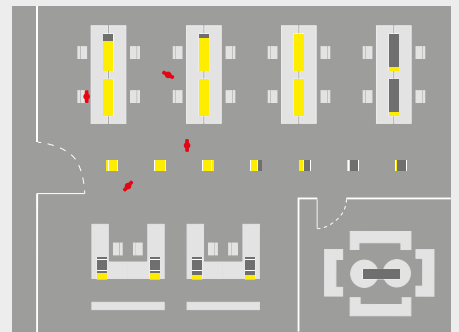

When the room empties at lunchtime, the light gradually falls to a lower level; then, at the end of the working day, the lights are shut off completely after a while.



# CUSTOMIZED SOLUTIONS



Architectural diversity and individuality increasingly make the case for specialized lighting solutions. As early as the planning phase, PERFORMANCE iN LIGHTING aligns your customer's design ideas with structural conditions. Each development step is carried out in close consultation with the customer, planner and architect. There is room for maneuver: whether low installation heights, joists or concrete ceilings, an eye-catching feature, playful accessories, individual LED solutions or high-performance work equipment – everything is possible.

PERFORMANCE iN LIGHTING can provide a new vision for every location, creating individual LED solutions to give form to your ideas.

With our award-winning LIGHT-PERFORMER® planning tool, you have the ability to configure your own lighting solution. You don't need specialist knowledge – LIGHT-PERFORMER® guides you carefully through the configuration procedure. More information about our configuration tool can be found on the following pages.



# LIGHT-PERFORMER®

Our outstanding assistant for your project planning





[www.light-performer.com](http://www.light-performer.com)



YouTube video

The LIGHT-PERFORMER® configuration tool provides all the answers to your questions. Visit [www.light-performer.com](http://www.light-performer.com) for quick and easy access to information and data, photometric files, prices and typical lighting configurations. LIGHT-PERFORMER® was awarded the iF Design Award 2018 in the Communication, Apps/Software category: Here, you will find all the materials in our entire standard product portfolio. LIGHT-PERFORMER® also allows you to individually configure even complex lighting systems in just a few minutes. The program provides you with all the data you need to make your choice:

data sheets, DXF drawings, installation instructions and gross prices. A special feature in LIGHT-PERFORMER® allows you to generate the appropriate light calculation file for your lighting system in .ULD and .ROLF format or as a Revit file. In a couple of clicks, you can export the photometric files to light planning software. No more onerous research or tedious waiting for prices: your project can be quickly and conveniently planned, thanks to LIGHT-PERFORMER®!

# LIGHT-PERFORMER®

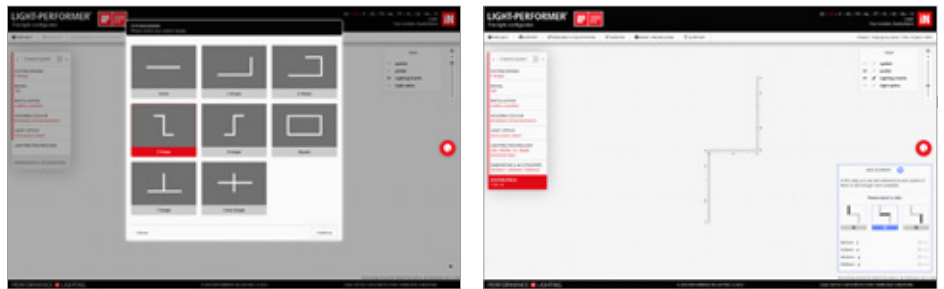

The LIGHT-PERFORMER® offers a fast and modular configuration in a few steps. The entire operation of the light configurator is easy and self-explaining; a complex lighting system is fully configured within 5 minutes. Small information buttons provide further information and advice.

In addition there is the possibility to make changes in retrospect in the "expert mode" - to change the configured system again.



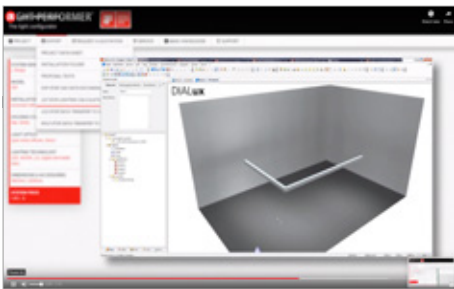

The user ends up with the opportunity to choose between different output options and, for example, to pass a photometric data file to the planning software DIALUX (.uld). Technical information and the photometric results are available immediately.



The complete configuration can be filed in a project folder and recalled later.

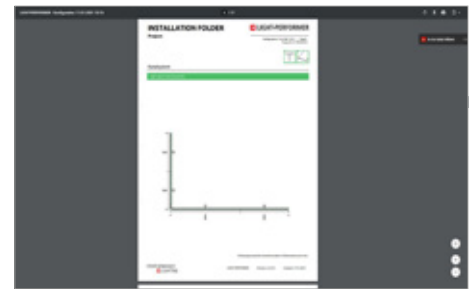

For any lighting system the LIGHT-PERFORMER draws up an individual well-matched assembly instruction for each phase of construction.

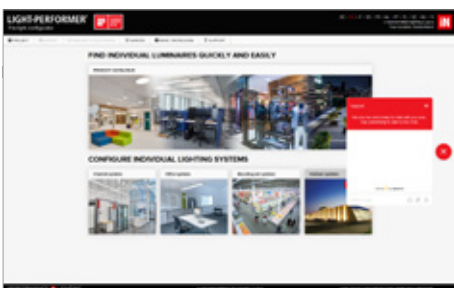

Chat function: Our employees answer your questions online



Search and find out a certain product among 5.000 catalogue products.



Do you need an offer? Is online-support required? Just request via mouse-click. Our technicians will train you online.



# CUSTOMIZED SOLUTIONS

Zalando headquarters | Munich | Germany | Berlin | Germany

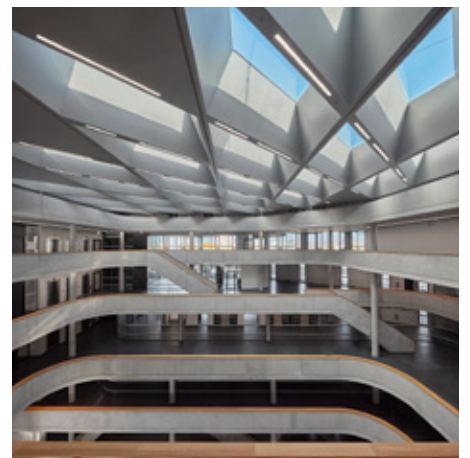
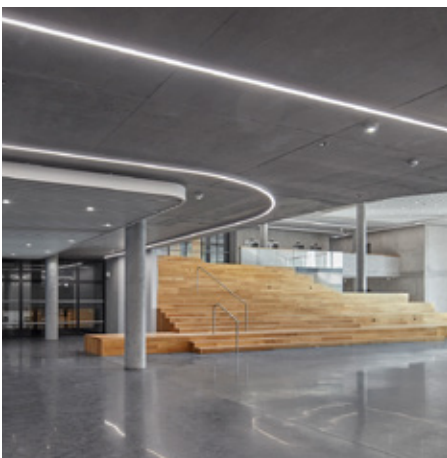



# CUSTOMIZED SOLUTIONS

Microsoft headquarters | Munich | Germany





# CUSTOMIZED SOLUTIONS

TAZ Berlin headquarters | Berlin | Germany



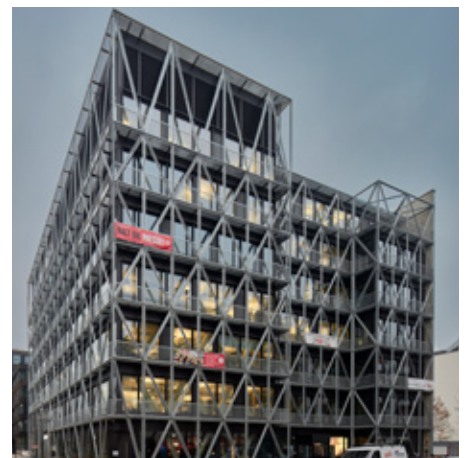
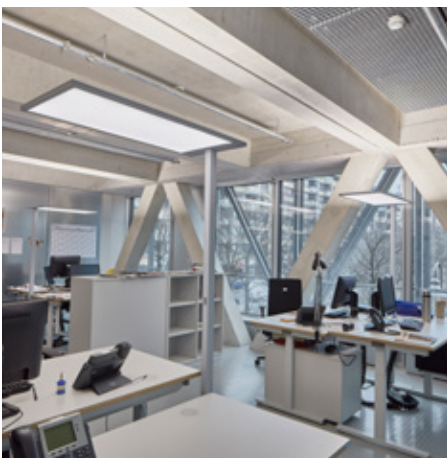
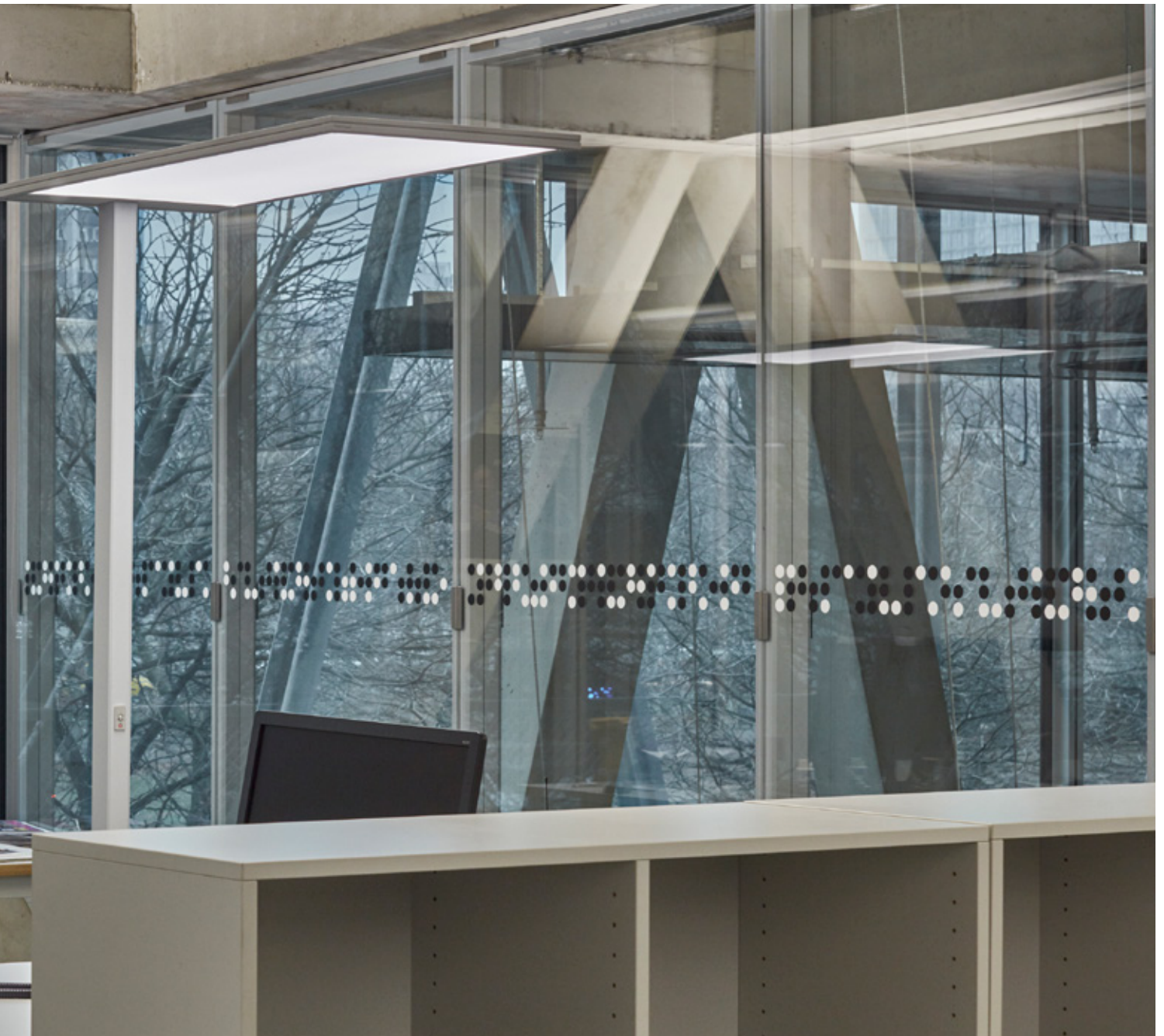



# CUSTOMIZED SOLUTIONS

Vetroin offices | Brescia | Italy





# CUSTOMIZED SOLUTIONS

Wisag offices | Frankfurt | Germany

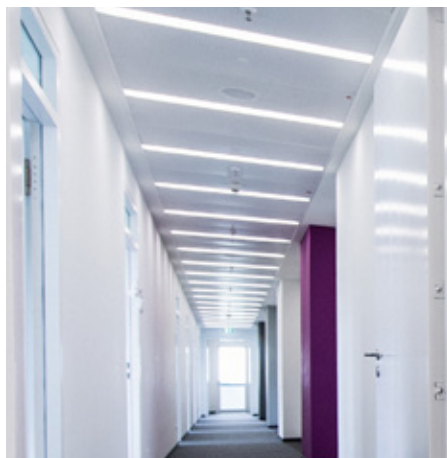



# CUSTOMIZED SOLUTIONS

Offices "Haus der Höfe" | Bonn | Germany

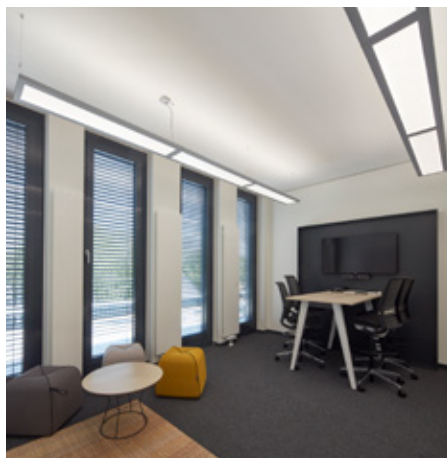



# CUSTOMIZED SOLUTIONS

Finstral customer centre | Goschheim | Germany







# CUSTOMIZED SOLUTIONS

Nordex offices | Hamburg | Germany

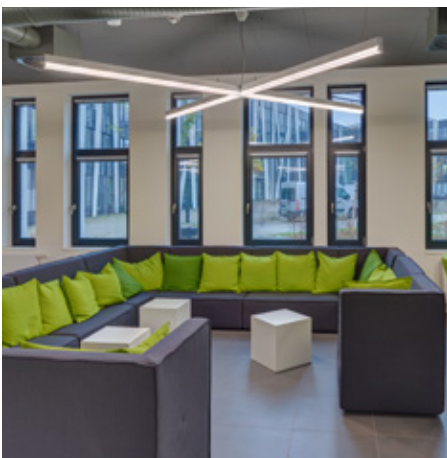



# CUSTOMIZED SOLUTIONS

Valetti cellar | Bardolino | Italy





To meet the customer's needs, PERFORMANCE iN LIGHTING has over the years established a vast and structured commercial network through subsidiary companies and distributors.

The Group now exports to more than 100 countries worldwide.

**PERFORMANCE iN LIGHTING S.p.A.**  
**Headquarters - Italy**  
Viale del Lavoro 9/11  
37030 Colognola ai Colli  
Verona - Italy  
Tel. +39 045 61 59 211  
Fax +39 045 61 59 292  
info.it@pil.lighting

**PERFORMANCE iN LIGHTING S.p.A.**  
**Bergamo business unit**  
Via Provinciale 57  
24050 Ghisalba  
Bergamo - Italy  
Tel. +39 0363 94 06 11  
Fax +39 0363 94 06 90  
info.it@pil.lighting

**PERFORMANCE iN LIGHTING GmbH**  
**Headquarters - Germany**  
Stapelner Str. 1+3  
38644 Goslar - Germany  
Tel. +49 (0) 5321 3777 0  
Fax +49 (0) 5321 3777 99  
info.de@pil.lighting

**PERFORMANCE iN LIGHTING GmbH**  
**München business unit**  
Hauptstraße 27  
82008 Unterhaching - Germany  
Tel. +49 (0) 89/66 54 76 87 230  
Fax +49 (0) 89/66 54 76 87 19  
info.de@pil.lighting

**PERFORMANCE iN LIGHTING GmbH**  
**Düsseldorf business unit**  
Leichlinger Str. 14  
40764 Langenfeld - Germany  
Tel. +49 (0) 21 73/2 71 99 10  
Fax +49 (0) 21 73/2 71 99 29  
info.de@pil.lighting

**PERFORMANCE iN LIGHTING BE**  
Chaussée de Haecht, 1880  
Haachtsesteenweg, 1880  
1130 Bruxelles / Brussel - Belgium  
Tel. + 32 2 705 51 51  
Fax + 32 2 705 12 87  
info.be@pil.lighting

**PERFORMANCE iN LIGHTING NEDERLAND**  
Ronde Tocht 1 C  
1507 CC Zaandam - The Netherlands  
Tel. + 31 75 6708 706  
info.nl@pil.lighting

**PERFORMANCE iN LIGHTING FRANCE S.A.S.**  
Parc d'Activités de la Couronne des Prés  
107 Avenue des Pâtis - CS 50608 Epône  
78417 Aubergenville Cedex - France  
Tel. +33 1 3090 5360  
info.fr@pil.lighting

**PERFORMANCE iN LIGHTING UK Ltd**  
Unit 4, Hepworth Park,  
Brook Street, Lakeside,  
Redditch, Worcestershire B98 8NZ - UK  
Tel. +44 (0) 1527 58 49 26  
Fax +44 (0) 1527 66 933  
info.uk@pil.lighting

**PERFORMANCE iN LIGHTING ESPAÑA S.A.**  
Pol. Industrial "La Llana"  
c/Pont de Can Claverí, 58  
08191 Rubí (Barcelona) - Spain  
Tel. +34 93 699 5554  
Fax +34 93 699 5045  
info.es@pil.lighting

**PERFORMANCE iN LIGHTING PORTUGAL**  
Estrada da Circunvalação 3558 / 3560  
4435-186 Porto - Portugal  
Tel. +351 229 770 624  
Fax +351 229 770 699  
info.pt@pil.lighting

**PERFORMANCE iN LIGHTING FINLAND Oy**  
Tikkurikuja 1  
00750 Helsinki - Finland  
Tel. +358 10422 1860  
Fax +358 10422 1861  
info.fi@pil.lighting

**PERFORMANCE iN LIGHTING USA, Inc.**  
2621 Keys Pointe  
Conyers GA 30013 - USA  
Phone +1 770 822 2115  
Fax +1 770 822 9925  
info.usa@pil.lighting

**PERFORMANCE iN LIGHTING - ISRAEL**  
Moshav Hagor Meshke 401, P.O.B. 9102 PT.  
Tel. +972 3 93 40 350  
Fax +972 3 93 40 350  
Mob +972 53 2280477

**PERFORMANCE iN LIGHTING MIDDLE EAST**  
Dubai Airport Free Zone  
P.O.Box. 371818, Dubai, U.A.E.  
Tel. +971 4 2395146  
info.me@pil.lighting





**PERFORMANCE iN LIGHTING S.p.A**

Viale del Lavoro 9/11

37030 Colognola ai Colli (VR) - Italy

T +39 045 61 59 211

F +39 045 61 59 393

[www.performanceinlighting.com](http://www.performanceinlighting.com)