



SPILLO | AREA LIGHTING | BOLLARDS

PRODUCT CODE

PROJECT

TYPE

PERFORMANCE
iN LIGHTING

powered by
GEWISS



Company

Performance in Lighting USA, located in Conyers, GA, is part of an international group of companies headquartered in Verona, Italy.

The group was formed from a number of well-established technical lighting companies from various countries. Performance in Lighting has a wide sales and distribution network operating in over 100 countries worldwide. Production facilities are located in Verona Italy, Bergamo Italy, Goslar Germany, Brussels Belgium, Conyers GA USA. Sales/distribution subsidiaries are located in England, Holland, France, Finland, Spain, Portugal, Australia, Dubai and Japan.

Recognized for its unique professional approach and technical know-how, Performance in Lighting has combined its international experience and technical expertise to become a worldwide leader in its industry. The group offers various lighting solutions worldwide for many applications including interior, exterior, residential, commercial, and sports lighting providing options to satisfy both architectural and engineering requirements.

Performance in Lighting USA concentrates on specification grade luminaires designed to provide a vast array of lighting solutions. Our concentration is outdoor products for illuminating commercial spaces from structural facades to parking areas. We strive to meet the demands of today's lighting community offering made in USA products, European designed with clean, contemporary aesthetics along with aggressive price points and fast lead times.

Pronto Program

PERFORMANCE IN LIGHTING offers a wide range of quick ship fixtures through the Pronto Program and a host of options to fit within the unique budget of your next project.





Overview

Click the QR-code for latest information.

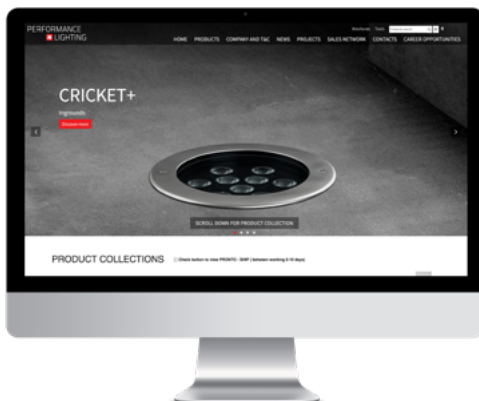

Website

Please visit our web site www.performanceinlighting.com/us/us/ for the latest updated versions available.



5-year warranty

All products are covered by a 5-year warranty, provided that they are used and maintained according to instructions. Focus on quality, safety and product lifetime/longevity are the essential objectives of PERFORMANCE IN LIGHTING. For additional information, email info.usa@pil.lighting

SPILLO

Starry light

The SPILLO is set to inspire the design community with the newest form factor in site and pedestrian lighting. Combining classic details and a modern aesthetic the SPILLO partners top performance with a cutting edge look. Offering Type II and V optical distributions and an industry leading sensor option that gives you precise energy controls, the SPILLO is not only the most beautiful exterior fixture available, it's the smartest too. With a complimentary bollard in the form of the SPILLO MINI this is the new standard in urban lighting.

In compliance with latest international light pollution / dark sky requirements SPILLO is the perfect choice for your residential and commercial projects.





K-Farm | Malo | Italy

SPILLO

Design-coordinated area and site lighting (SPILLO) and bollard (SPILLO MINI) series. Fixtures consists of:

CONSTRUCTION

- Multi-step powder-coat painting process, optimized against UV rays and corrosion.
- Copper-free precision die-cast aluminum housing and top cap.
- Copper-free aluminum extruded post.
- Custom MCPCB utilized to maximize heat dissipation and promote long LED life.
- High-transmittance transparent optics.
- Custom molded, anti-aging gasket(s).
- Stainless steel external hardware.

INSTALLATION

- Available in two standard sizes of Ø14.2" (SPILLO MINI) and Ø22.8" (SPILLO).
- The "Secure Light Distribution" system can bypass individual diodes in the event of a single LED failure to ensure continuous uniform light distribution.
- Pre-wired factory sealed cable for external electrical connection included.
- Ø3" and Ø4" post top adapters, and poles in 8' / 10' / 12' / 14' options available (ordered separately).
- Anchor bolts available for bollards (ordered separately).

OPTICS

- Type V and Type II (SPILLO only) light distributions.

ELECTRICAL

- Input voltage: 120-277 V (50 / 60 Hz), integral 0-10 V dimming driver.
- Integral surge protector can withstand up to 10 kV transient line surge.

OPTIONS

- The luminaire may be configured with numerous options and multiple standard finishes. Not all options are available in all configurations. Consult factory for more information about specification sheet details.

LISTINGS

- UL Wet location listed. IP65 rated.
- Product meets Buy American requirements within ARRA.
- Photometric data measured according to UNI EN 13032-1/4 and IES LM-79-08
- The light distribution complies with the IESNA Full Cut-Off Classification and is eligible for all "Dark Sky" applications when aimed down.
- Actual performance may differ as a result of the end-user environment and application. All values are design or typical values, measured under laboratory conditions at 25 °C. Specifications are subject to change without notice.

WARRANTY

- 5-year limited warranty. Complete warranty terms located at www.performanceinlighting.com



SPILLO



SPILLO MINI

SPILLO MINI



The light distribution complies with the IESNA Full Cut-Off Classification and is eligible for all "Dark Sky" applications.

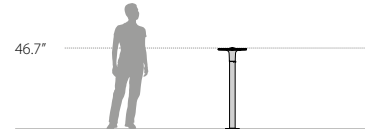

Pre-wired factory sealed cable for external electrical connection included.



Each LED is coupled with an electronic safety device (NUD) that can by-pass it in case of failure

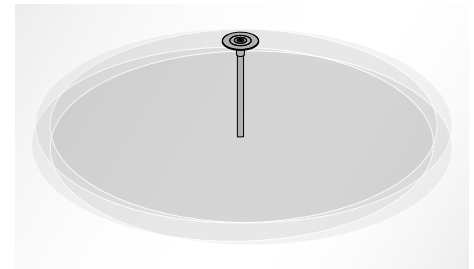

The "Secure Light Distribution" system can bypass individual diodes in the event of a single LED failure to ensure continuous uniform light distribution.



Anchor bolts available (to be ordered separately).

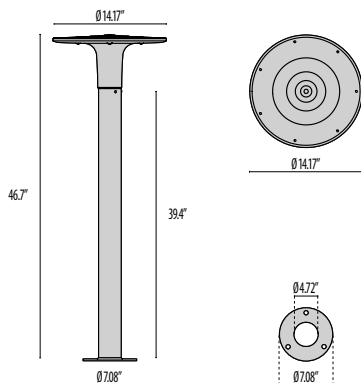

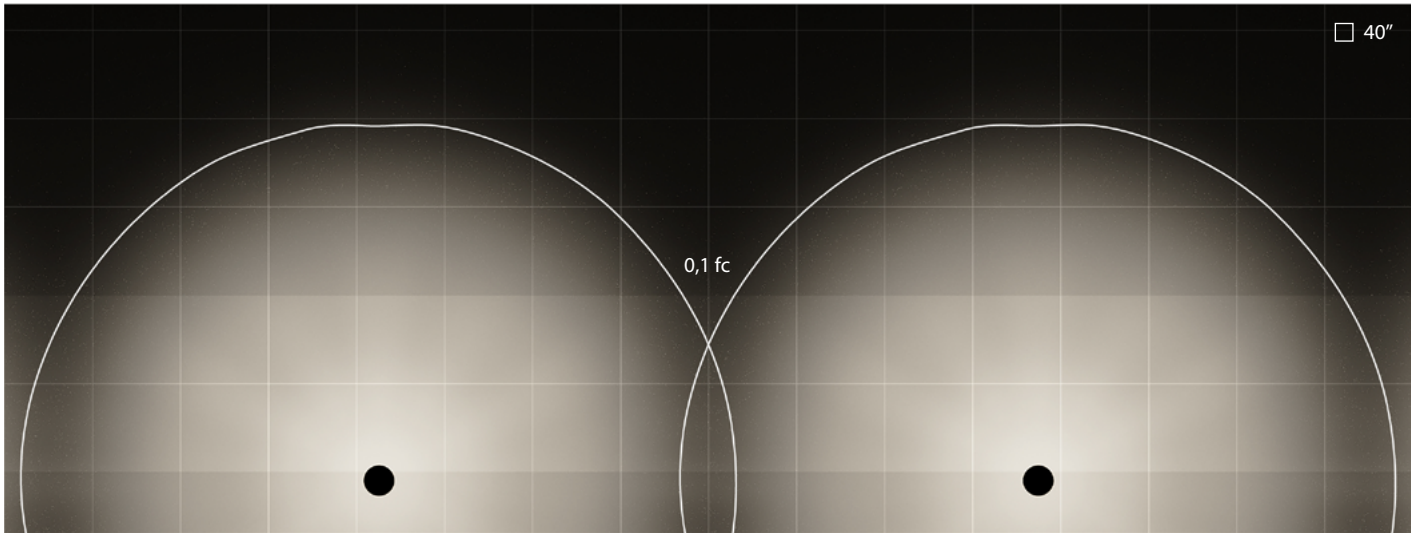

SPILLO MINI | TYPEV | linear

Luminaire spacing = 24' 7" (7.5m)
 Path depth = 6' 7" (2m)
 Mounting height = 0" (0m)

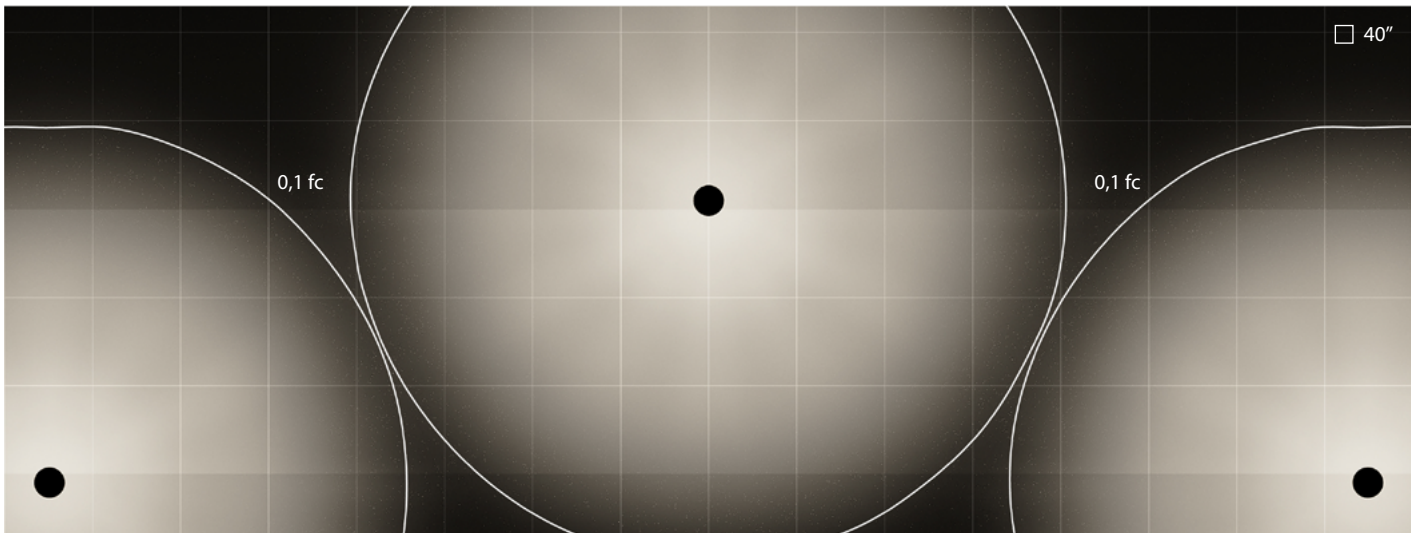

SPILLO MINI | TYPEV | qunconce

Luminaire spacing = 24' 7" (7.5m)
 Path depth = 9' 10" (3m)
 Mounting height = 0" (0m)

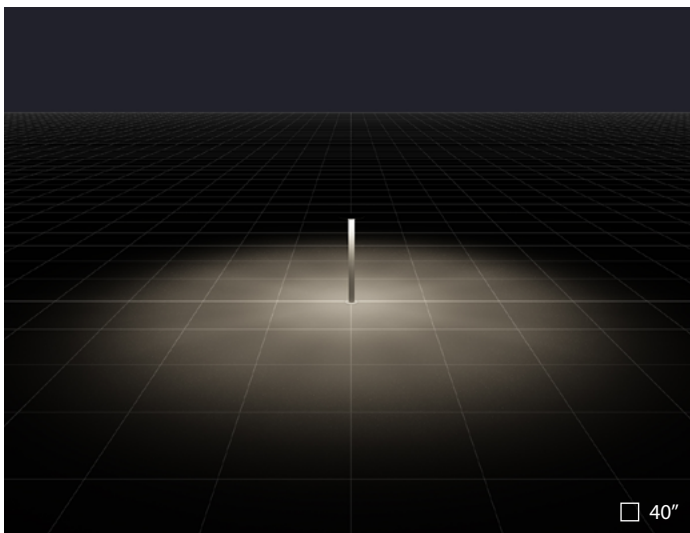

SPILLO MINI | TYPEV

SPILLO



The light distribution complies with the IESNA Full Cut-Off Classification and is eligible for all "Dark Sky" applications.

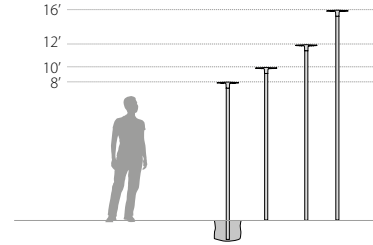

External electrical connection with sealed plug-socket QUICK, complete with cable



Future proof. It is possible to replace the LED boards to keep the luminaire technologically updated through the years (consult factory)

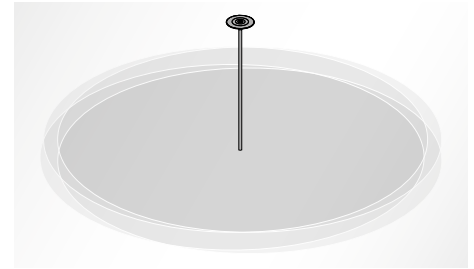

The "Secure Light Distribution" system can bypass individual diodes in the event of a single LED failure to ensure continuous uniform light distribution.



Ø3" and Ø4" post top adapters, and poles in 8' / 10' / 12' / 16' options available (to be ordered separately).

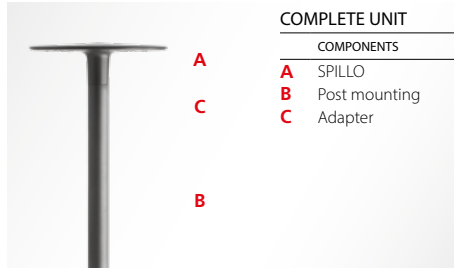

For products that must be mounted on a post, bracket, track or recessed into the wall, it is often necessary to order several different parts (codes) to get the complete configuration.

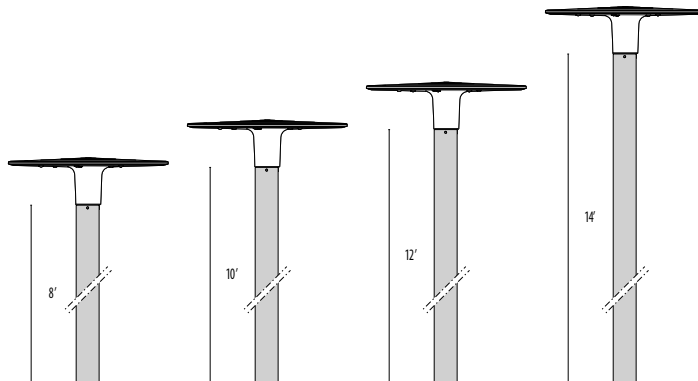
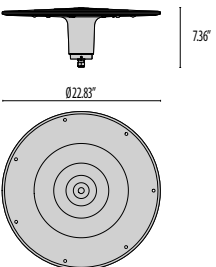

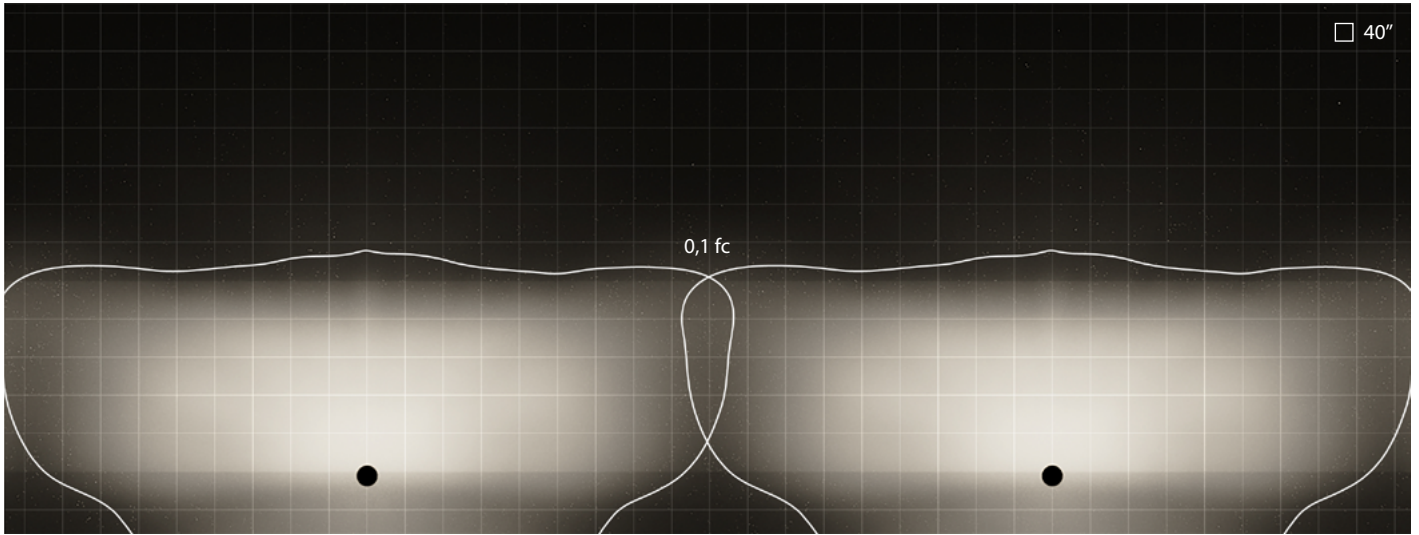

SPILLO | TYPE II | linear

Luminaire spacing = 59' 1" (18m)
 Path depth = 16' 5" (5m)
 Mounting height = 9' 10" (3m)

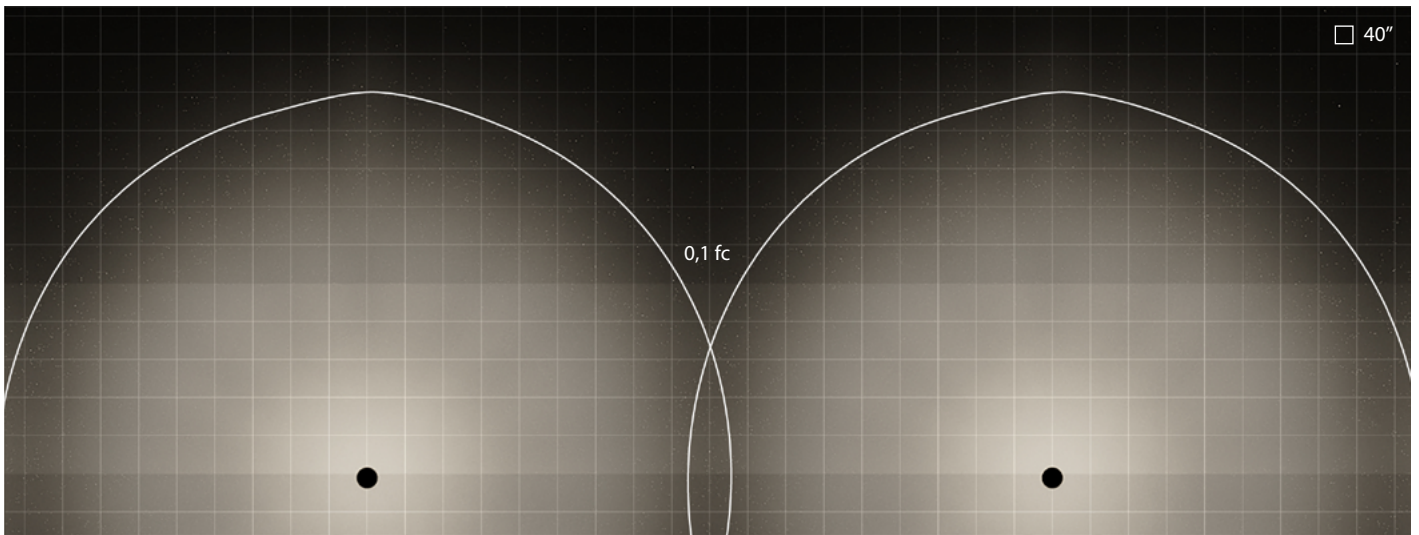

SPILLO | TYPE V | linear

Luminaire spacing = 59' 1" (18m)
 Path depth = 16' 5" (5m)
 Mounting height = 9' 10" (3m)

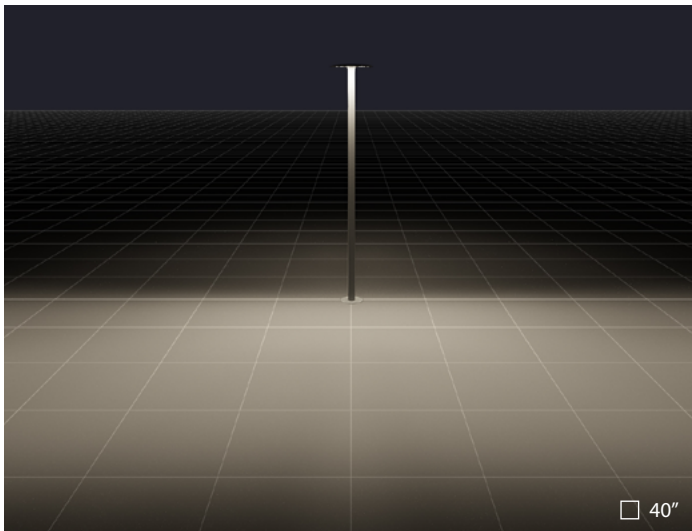

SPILLO | TYPE II

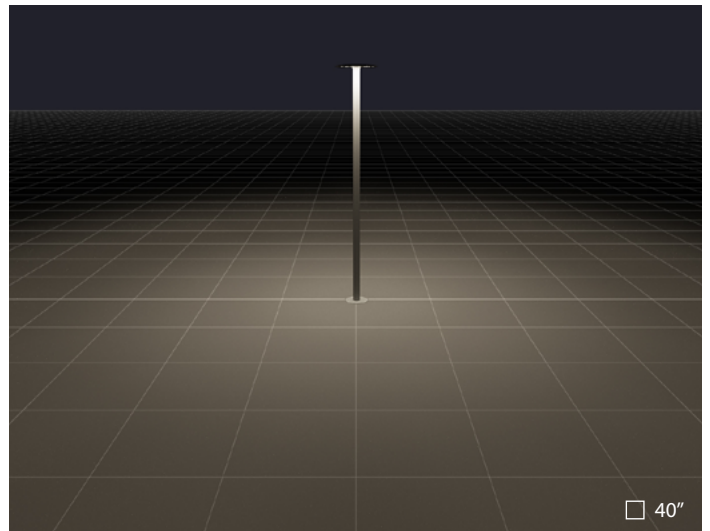

SPILLO | TYPE V

PERFORMANCE
IN LIGHTING

powered by
GEWISS

PERFORMANCE IN LIGHTING
2621 Keys Pointe
Conyers, GA 30013 - United States
Ph 770.822.2115
Fax 770.822.9925

www.performanceinlighting.com