



PADO | BOLLARDS

PRODUCT CODE

PROJECT

TYPE

PERFORMANCE
in LIGHTING

powered by
GEWISS



Company

Performance in Lighting USA, located in Conyers, GA, is part of an international group of companies headquartered in Verona, Italy.

The group was formed from a number of well-established technical lighting companies from various countries. Performance in Lighting has a wide sales and distribution network operating in over 100 countries worldwide. Production facilities are located in Verona Italy, Bergamo Italy, Goslar Germany, Brussels Belgium, Conyers GA USA. Sales/distribution subsidiaries are located in England, Holland, France, Finland, Spain, Portugal, Australia, Dubai and Japan.

Recognized for its unique professional approach and technical know-how, Performance in Lighting has combined its international experience and technical expertise to become a worldwide leader in its industry. The group offers various lighting solutions worldwide for many applications including interior, exterior, residential, commercial, and sports lighting providing options to satisfy both architectural and engineering requirements.

Performance in Lighting USA concentrates on specification grade luminaires designed to provide a vast array of lighting solutions. Our concentration is outdoor products for illuminating commercial spaces from structural facades to parking areas. We strive to meet the demands of today's lighting community offering made in USA products, European designed with clean, contemporary aesthetics along with aggressive price points and fast lead times.

Pronto Program

PERFORMANCE IN LIGHTING offers a wide range of quick ship fixtures through the Pronto Program and a host of options to fit within the unique budget of your next project.





Overview

Click the QR-code for latest information.

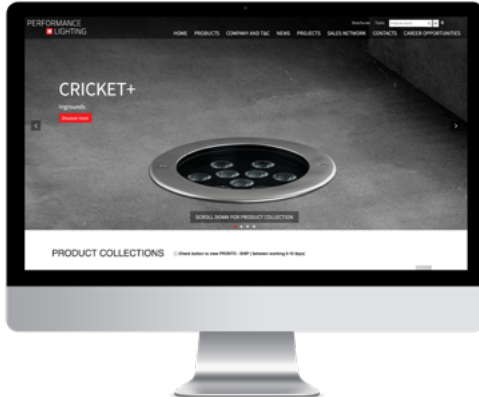

Website

Please visit our web site www.performanceinlighting.com/us/us/ for the latest updated versions available.



5-year warranty

All products are covered by a 5-year warranty, provided that they are used and maintained according to instructions. Focus on quality, safety and product lifetime/longevity are the essential objectives of PERFORMANCE IN LIGHTING. For additional information, email info.usa@pil.lighting

Protect the friendly skies

This simple bollard available in two standard heights is your perfect choice for walkways, obstacles or boundaries, a decorative element, or a safety feature.

The PADO Bollard series takes a simple and clean design and pairs it with over 1000 delivered lumens to give you a bollard that works from the gardens of a residential complex to the pedestrian paths of a commercial project. With a performance that gives you up to a 19' on center spacing to achieve a .5fc maintained and the most cost effective pricing in the marketplace, the PADO makes for an obvious solution for your next design proposal.

In compliance with latest international light pollution / dark sky requirements PADO is the perfect choice for your residential and commercial projects.





Residence "La Valle" | Barco di Lavagno | Italy

PADO

Pathway bollard series. Fixtures consist of:

CONSTRUCTION

- Multi-step powder-coat painting process, optimized against UV rays and corrosion.
- Copper-free precision die-cast aluminum housing and top cap.
- Copper-free aluminum extruded post.
- High-efficiency COB, combined with an optimized passive cooling system, provides a long LED life.
- Frosted, tempered, silk-screened, flat glass diffuser.
- Custom molded, anti-aging gasket(s).
- Stainless steel external hardware.

INSTALLATION

- Available in two standard heights of 26" (PADO 600) and 38" (PADO 900).
- Pre-wired factory sealed cable for external electrical connection included.

OPTICS

- Type V overall light distribution.

ELECTRICAL

- Input voltage: 120-277 V (50 / 60 Hz), integral 0-10 V dimming driver.

OPTIONS

- The luminaire may be configured with numerous options and multiple standard finishes. Not all options are available in all configurations. Consult factory for more information about specification sheet details.

LISTINGS

- UL Wet location listed. IP65 rated.
- Product meets Buy American requirements within ARRA.
- Consult factory for which version qualifies for the PRONTO-SHIP program. All Rough-Ins are available to ship within 48-72 hrs. Orders must be marked "PRONTO."
- Photometric data measured according to UNI EN 13032-1/4 and IES LM-79-08
- The light distribution complies with the IESNA Full Cut-Off Classification and is eligible for all "Dark Sky" applications when aimed down.
- Actual performance may differ as a result of the end-user environment and application. All values are design or typical values, measured under laboratory conditions at 25 °C. Specifications are subject to change without notice.

WARRANTY

- 5-year limited warranty. Complete warranty terms located at www.performanceinlighting.com



PADO 26"

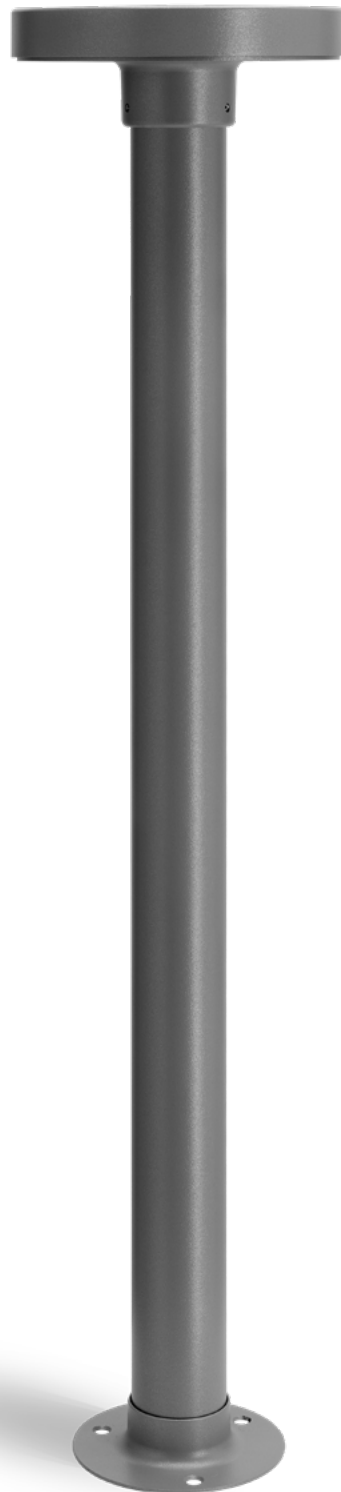

PADO 38"

PADO

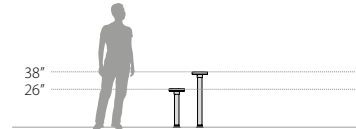

The light distribution complies with the IESNA Full Cut-Off Classification and is eligible for all "Dark Sky" applications and local light trespass ordinances (bollard and/or area and site lighting versions).



Pre-wired factory sealed cable for external electrical connection included.



High-efficiency COB combined with an optimized passive cooling system provides a long LED life.

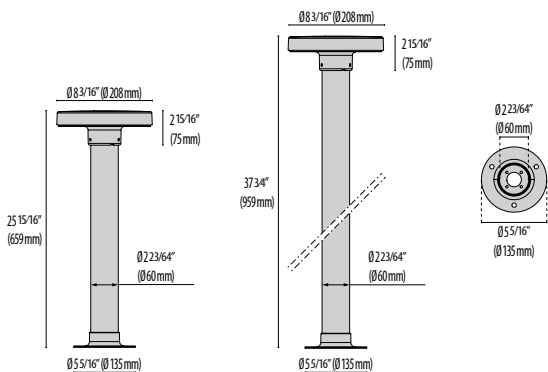

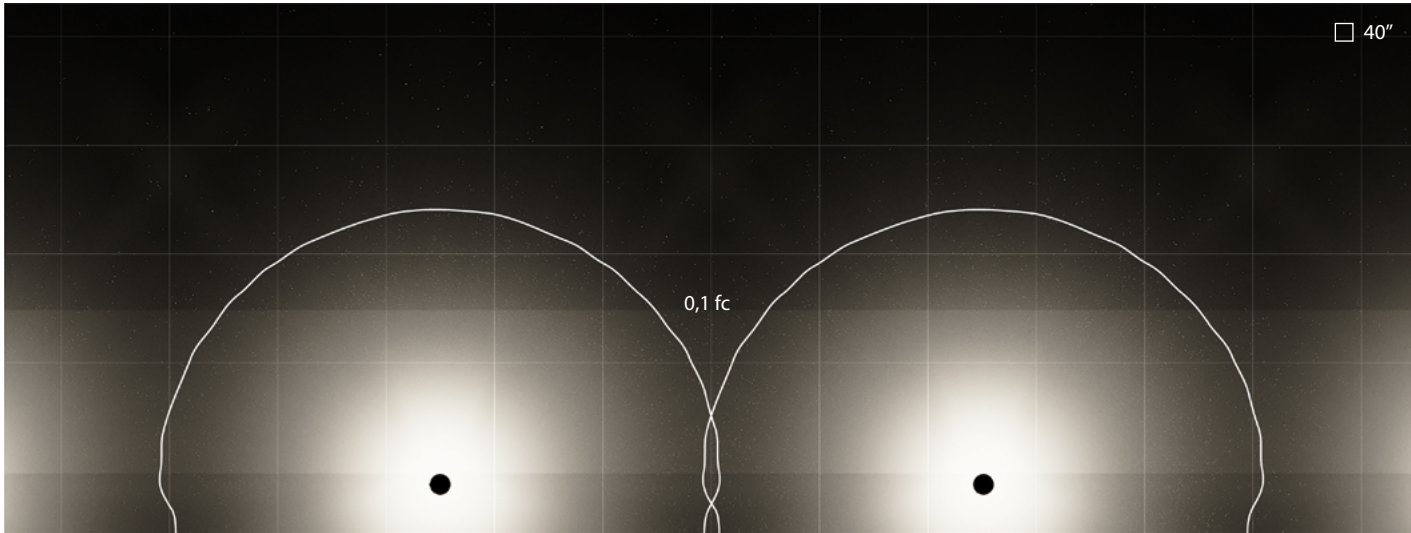

PADO 26" | Circular Extra-Wide optics | TYPE V | linear

Luminaire spacing = 16'5" (5m)
 Path depth = 4'11" (1.5m)
 Mounting height = 0" (0m)

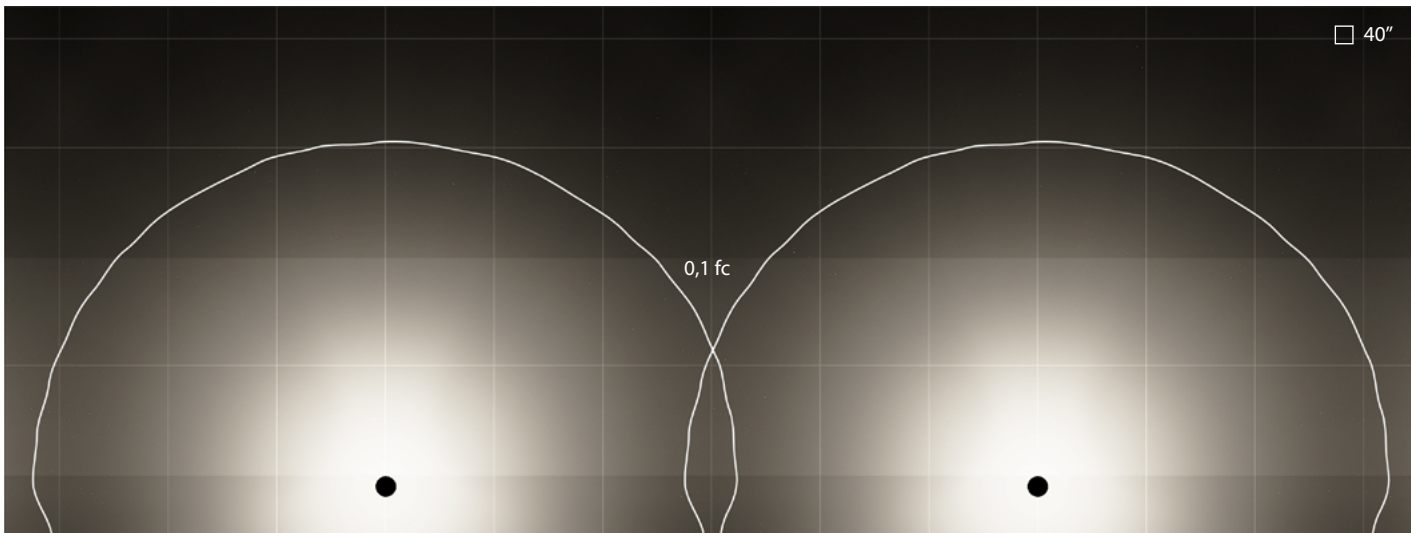

PADO 36" | Circular Extra-Wide optics | TYPE V | linear

Luminaire spacing = 19'8" (6m)
 Path depth = 6'7" (2m)
 Mounting height = 0" (0m)

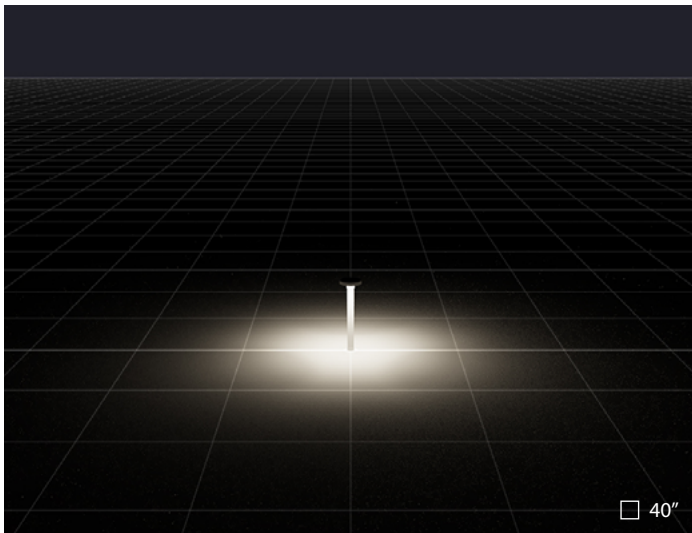

PADO 26" | Circular Extra-Wide optics | TYPE V

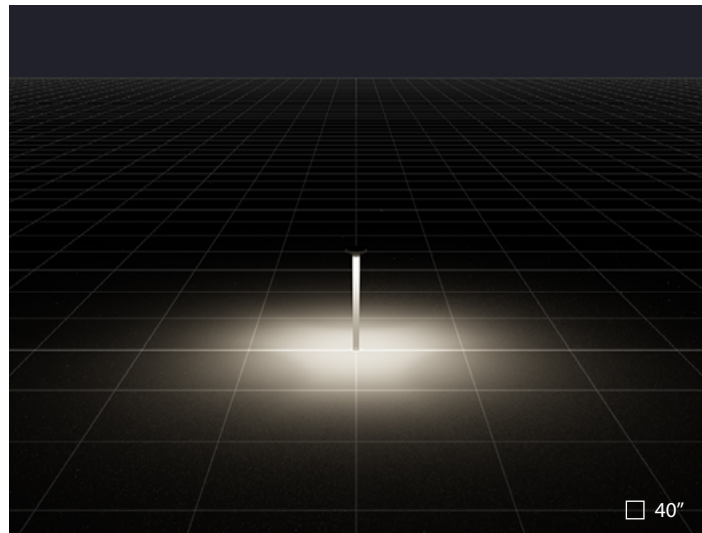

PADO 36" | Circular Extra-Wide optics | TYPE V

PERFORMANCE
IN LIGHTING

powered by
GEWISS

PERFORMANCE IN LIGHTING
2621 Keys Pointe
Conyers, GA 30013 - United States
Ph 770.822.2115
Fax 770.822.9925

www.performanceinlighting.com