



FOCUS+ | FLOODLIGHTS | WALL MOUNTED

PRODUCT CODE

PROJECT

TYPE

PERFORMANCE
in LIGHTING

powered by
GEWISS



Company

Performance in Lighting USA, located in Conyers, GA, is part of an international group of companies headquartered in Verona, Italy.

The group was formed from a number of well-established technical lighting companies from various countries. Performance in Lighting has a wide sales and distribution network operating in over 100 countries worldwide. Production facilities are located in Verona Italy, Bergamo Italy, Goslar Germany, Brussels Belgium, Conyers GA USA. Sales/distribution subsidiaries are located in England, Holland, France, Finland, Spain, Portugal, Australia, Dubai and Japan.

Recognized for its unique professional approach and technical know-how, Performance in Lighting has combined its international experience and technical expertise to become a worldwide leader in its industry. The group offers various lighting solutions worldwide for many applications including interior, exterior, residential, commercial, and sports lighting providing options to satisfy both architectural and engineering requirements.

Performance in Lighting USA concentrates on specification grade luminaires designed to provide a vast array of lighting solutions. Our concentration is outdoor products for illuminating commercial spaces from structural facades to parking areas. We strive to meet the demands of today's lighting community offering made in USA products, European designed with clean, contemporary aesthetics along with aggressive price points and fast lead times.

Pronto Program

PERFORMANCE IN LIGHTING offers a wide range of quick ship fixtures through the Pronto Program and a host of options to fit within the unique budget of your next project.





Overview

Click the QR-code for latest information.

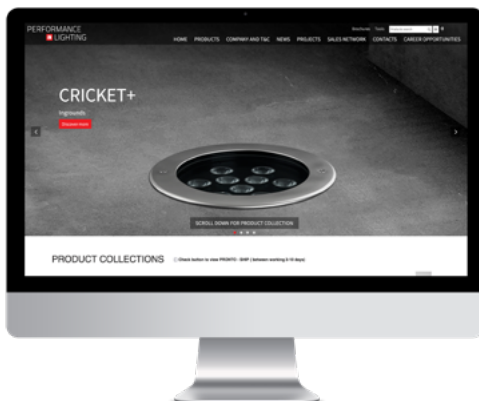

Website

Please visit our web site www.performanceinlighting.com/us/us/ for the latest updated versions available.



5-year warranty

All products are covered by a 5-year warranty, provided that they are used and maintained according to instructions. Focus on quality, safety and product lifetime/longevity are the essential objectives of PERFORMANCE IN LIGHTING. For additional information, email info.usa@pil.lighting

FOCUS+

Enhance every detail

Artificial light plays an essential role in the environment during night time: it provides orientation, transmits mood and emotions and draws attention.

FOCUS+, a series of luminaires designed to offer high performance with LED sources amongst the most efficient and updated in the marketplace, is functional and a clever choice for today's lighting needs. FOCUS+ is a great choice of compact floodlights specifically suited to enhance architectural details, to illuminate vertical and horizontal surfaces as well as other typical architectural landscape needs.

The range of beam distributions and wattages offer various options to enhance your project.





Chapel of the Holy Shroud | Turin | Italy

FOCUS+

Long-lasting energy-efficient architectural, landscape and professional flood light series. Fixtures consist of:

CONSTRUCTION

- Multi-step powder-coat painting process, optimized against UV rays and corrosion.
- Copper-free precision die-cast aluminum housing, ring/faceplate, and adjustable mounting arm.
- Custom MCPCB utilized to maximize heat dissipation and promote long LED life.
- High-transmittance transparent optics.
- Extra-clear, tempered, silk-screened, flat glass diffuser.
- Custom molded, anti-aging gasket(s).
- Stainless steel external hardware.

INSTALLATION

- Available in three standard sizes of H5.2" x L3.1" x D1.2" (FOCUS+ ZERO), H8.8" x L6.3" x D1.7" (FOCUS+ 1) and H11.8" x L8.7" x D2" (FOCUS+ 2 / 3).
- Pre-wired factory sealed cable for external electrical connection included.
- Standard swivel arm (SA versions) for a simplified installation.
- Technopolymer ground spike accessory available for FOCUS+ ZERO (ordered separately).
- Matching junction box plate optional accessory available (ordered separately).

OPTICS

- Circular Intensive (C/I), Medium (C/M), Wide (C/W), Elliptical (ELL), NEMA 6H x 7V (ZERO versions), 3H x 7V (Type I), 5H x 6V (Type IV), and 5H x 7V (Type III) optics and light distributions.

ELECTRICAL

- Input voltage: 120 V; Integral D.O.B. module with surge protection up to 500 V (FOCUS+ ZERO) and 120-277 V (50 / 60 Hz), integral 0-10 V dimming driver (FOCUS+ 1 / 2 / 3).

OPTIONS

- The luminaire may be configured with numerous options and multiple standard finishes. Not all options are available in all configurations. Consult factory for more information about specification sheet details.

LISTINGS

- UL Wet location listed. IP65 rated (FOCUS+ ZERO).
- UL Wet location listed. IP66 rated.
- Product meets Buy American requirements within ARRA.
- Consult factory for which version qualifies for the PRONTO-SHIP program. All Rough-Ins are available to ship within 48-72 hrs. Orders must be marked "PRONTO."
- Photometric data measured according to UNI EN 13032-1/4 and IES LM-79-08
- Actual performance may differ as a result of the end-user environment and application. All values are design or typical values, measured under laboratory conditions at 25 °C. Specifications are subject to change without notice.

WARRANTY

- 5-year limited warranty. Complete warranty terms located at www.performanceinlighting.com

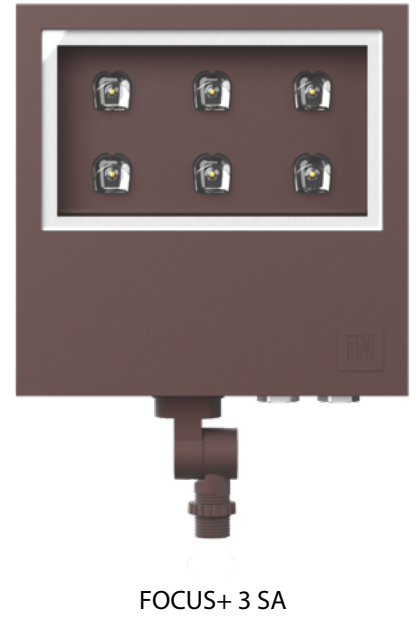
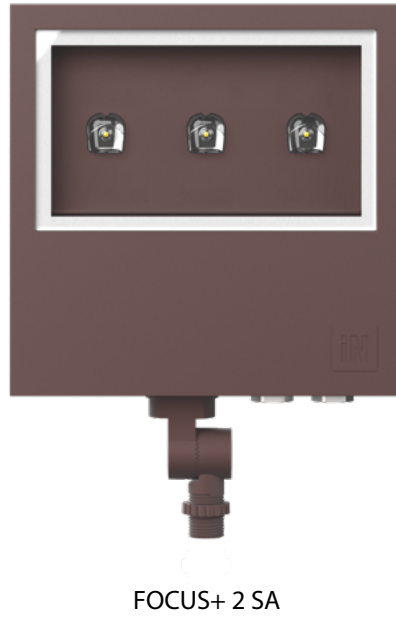
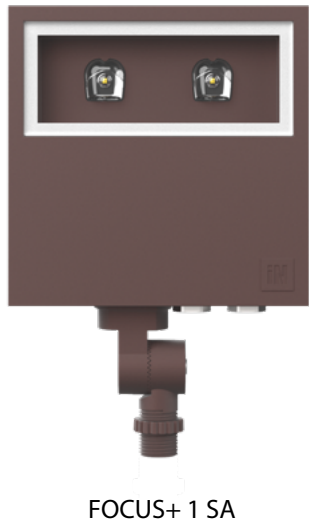

FOCUS+ ZERO



Standard slipfitter (SA versions) for a simplified installation.



Rotation $\pm 145^\circ$.



Aluminum reflector.

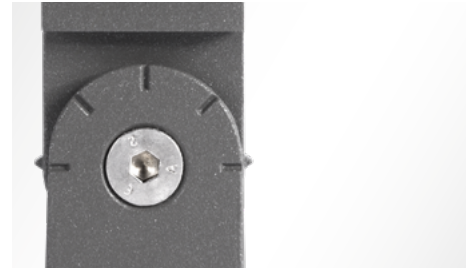

Adjustable mounting bracket made of die-cast aluminum.



Pre-wired cable is factory sealed to housing with a cable gland allowing external electrical connections.



Ground spike available as accessory.

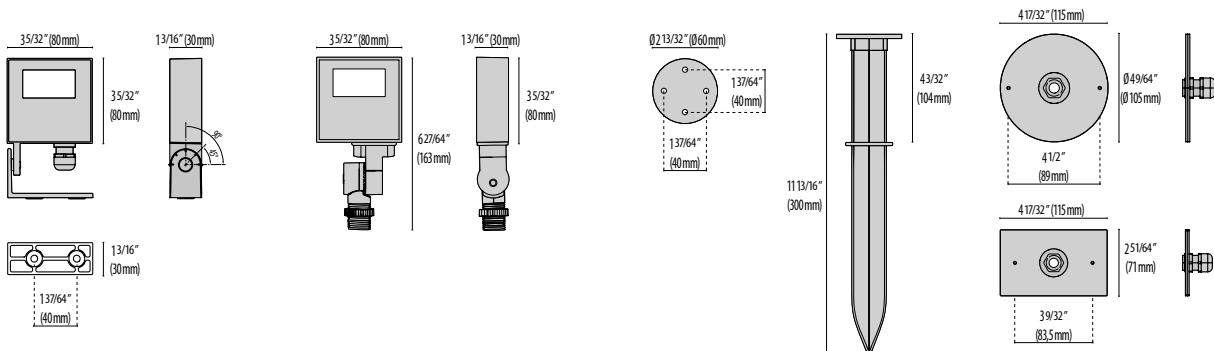

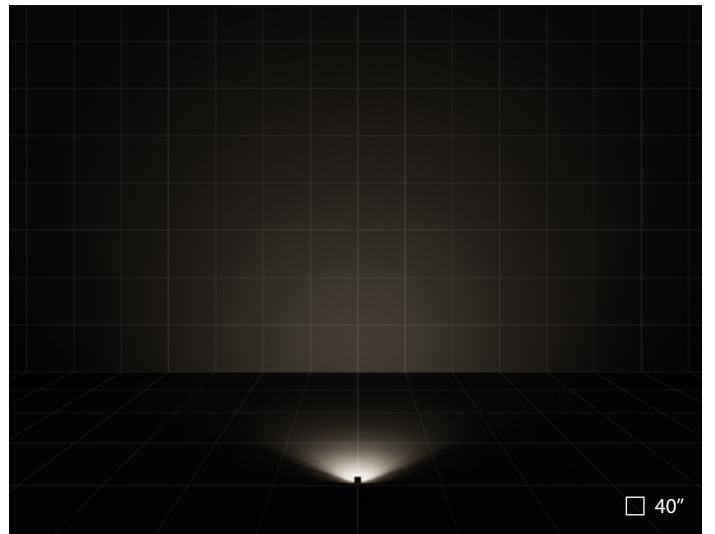
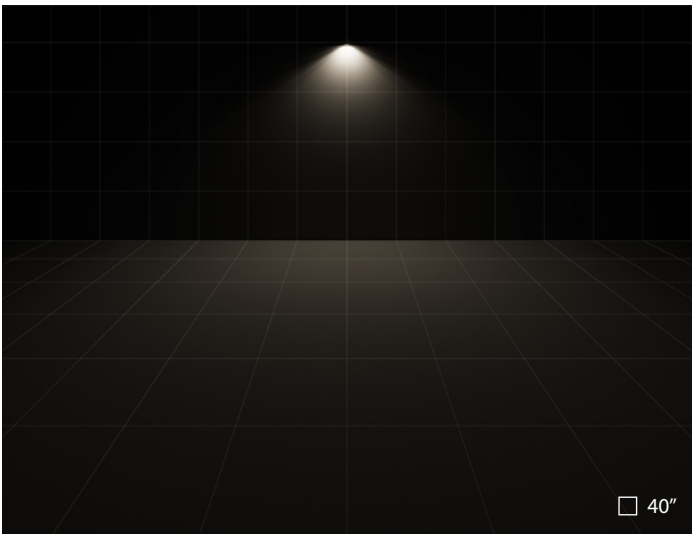

FOCUS+ ZERO | S/EW Symmetric Extra-Wide optics

FOCUS+ 1 / 2 / 3

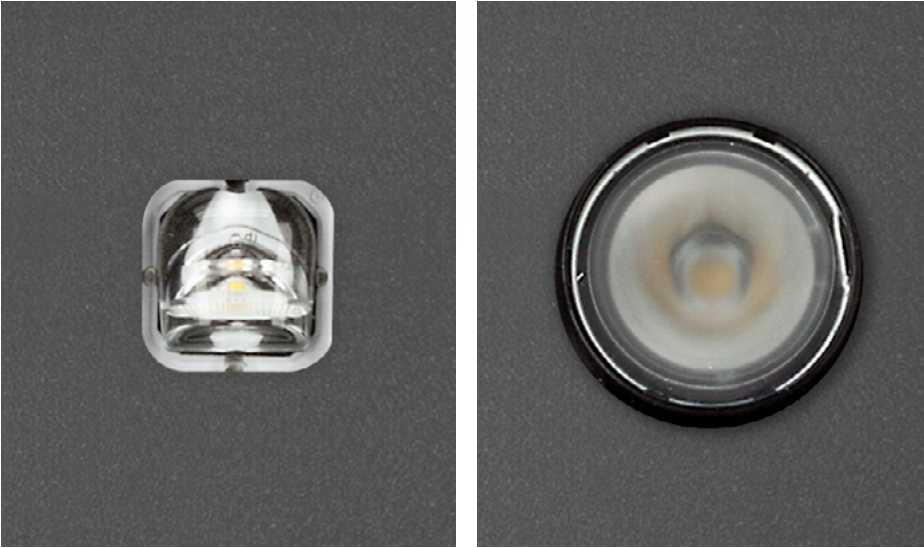

Equipped with high-transmittance polycarbonate lenses with different light distributions to meet the most diverse lighting requirements.



Adjustable mounting bracket made of die-cast aluminum. Allows for $\pm 90^\circ$ rotation.



Each fixture has through-wiring capability.



Die-cast painted aluminum housing and trim. Heat sinking body (FOCUS+ 2 / 3).



Standard swivel arm (SA versions) for a simplified installation.

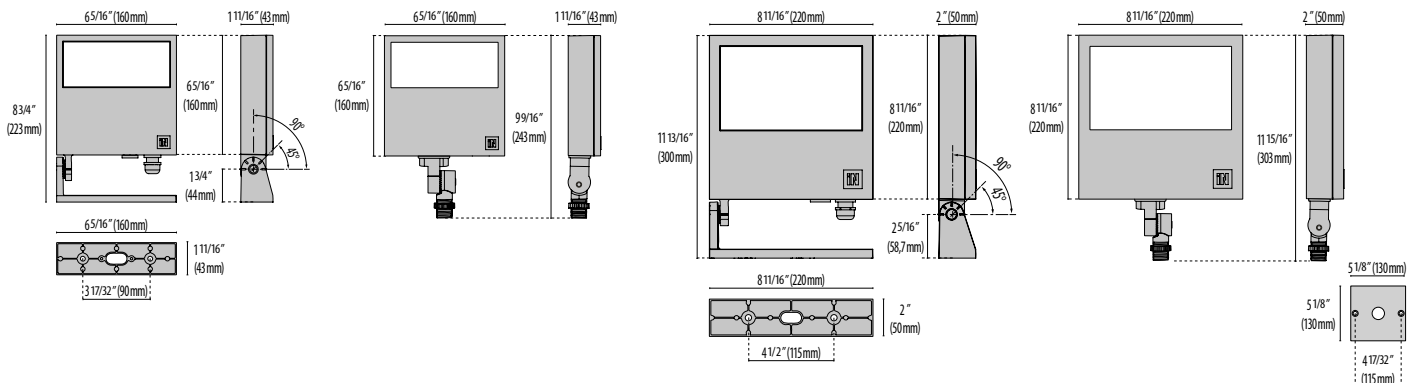



Church of the Blessed Virgin Mary | Borgo Nuovo - Verona | Italy

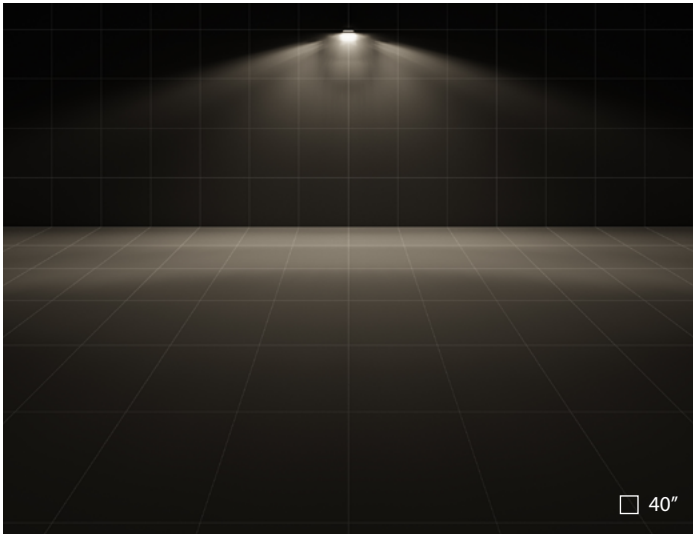

FOCUS+ 2 | TYPE I | NEMA 3H x 7V

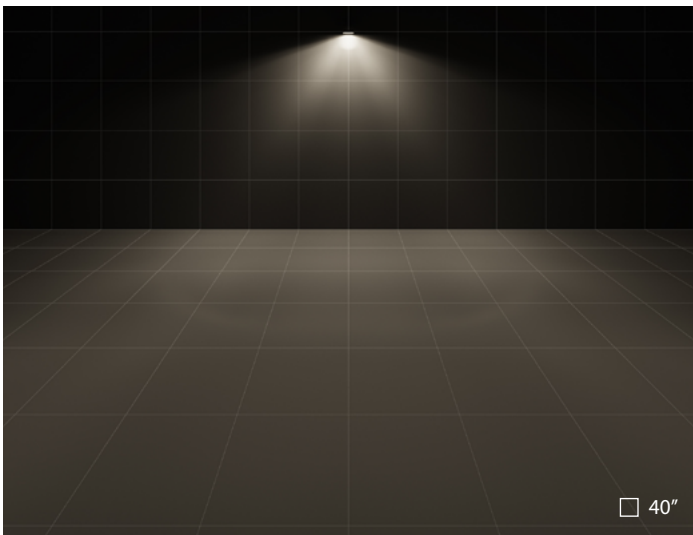
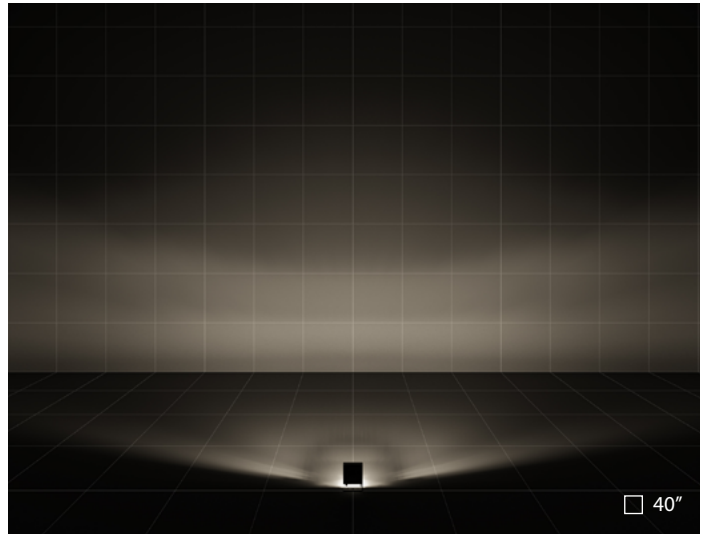

FOCUS+ 2 | TYPE III | NEMA 5H x 7V

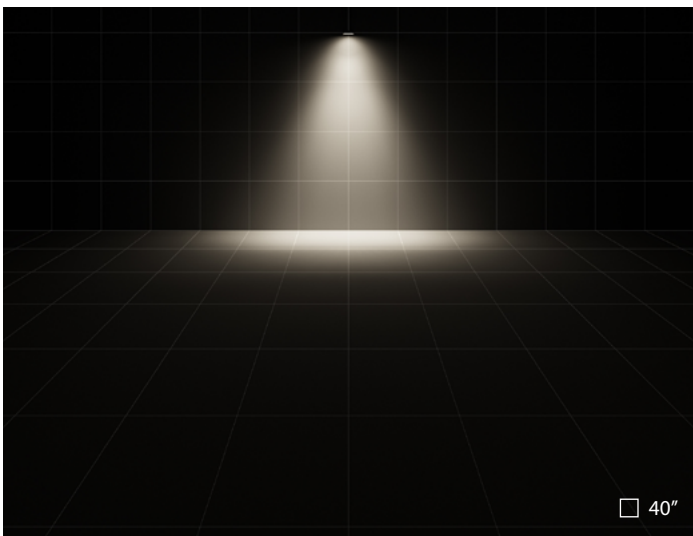
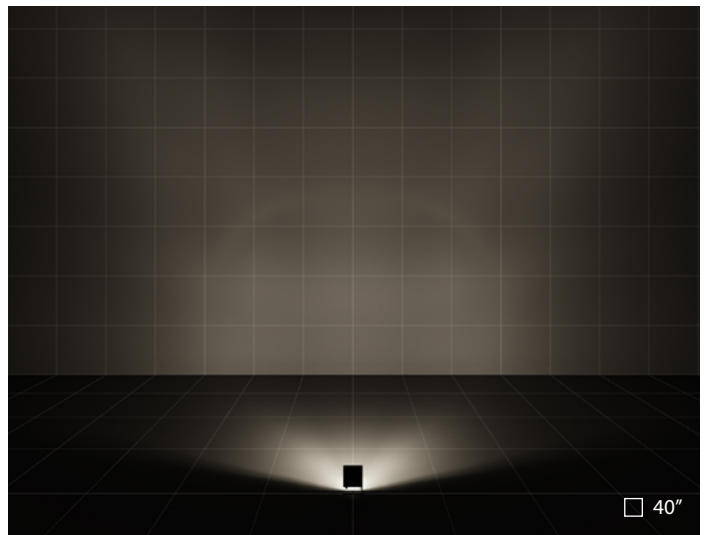

FOCUS+ 2 | ELL 15°x40° Elliptical optics

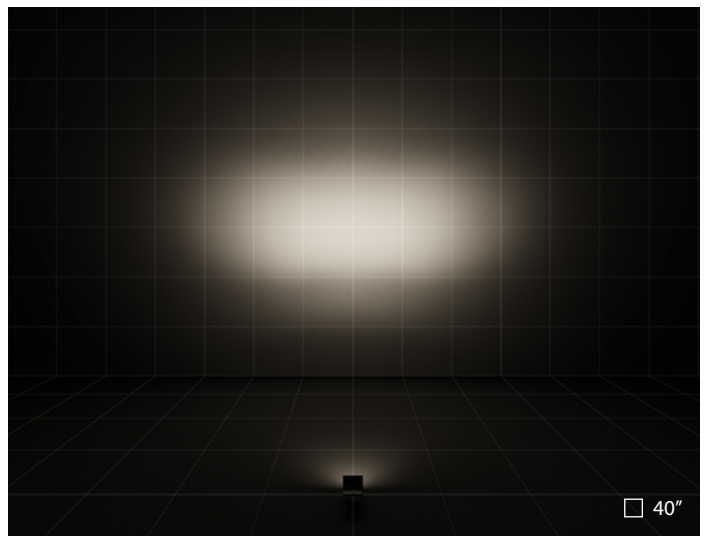

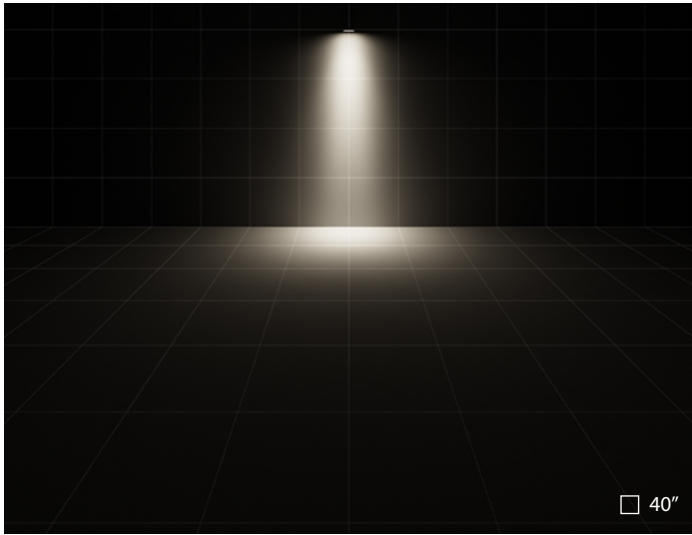

FOCUS+ 2 | C/I 17° Circular Intensive optics

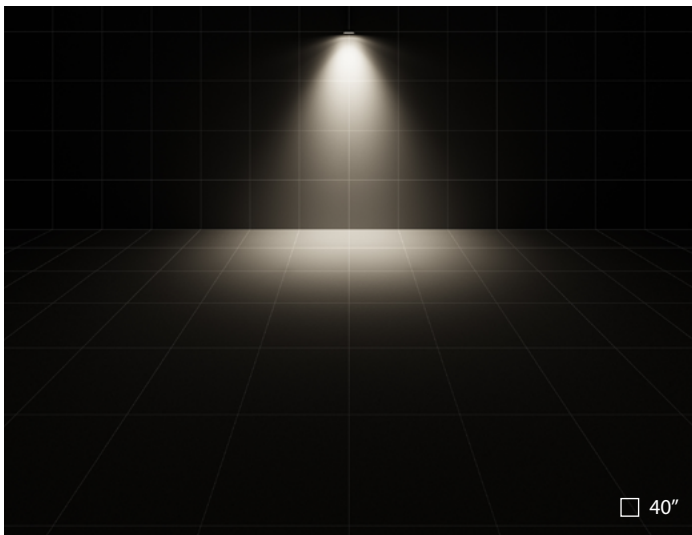
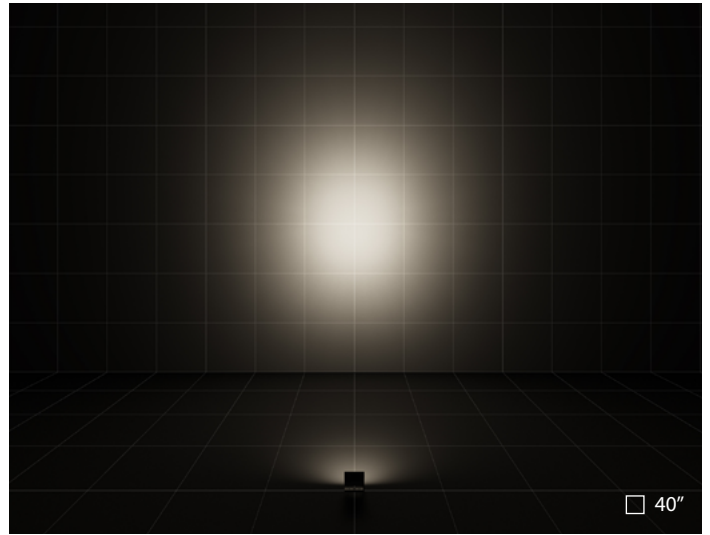

FOCUS+ 2 | C/M 34° Circular Medium optics

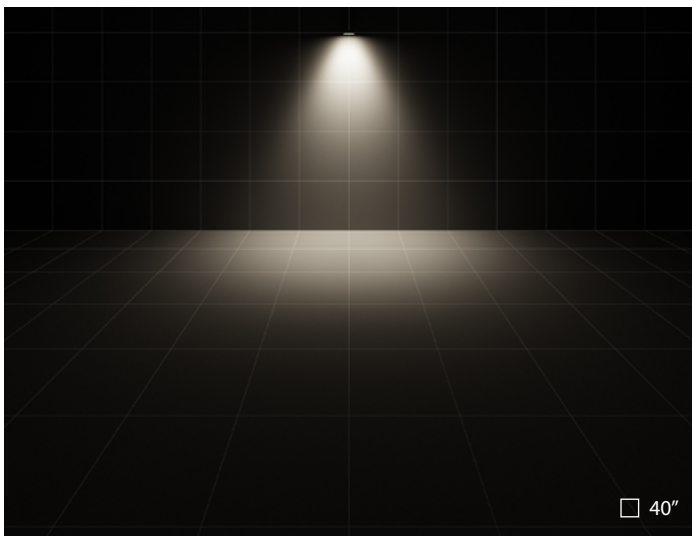
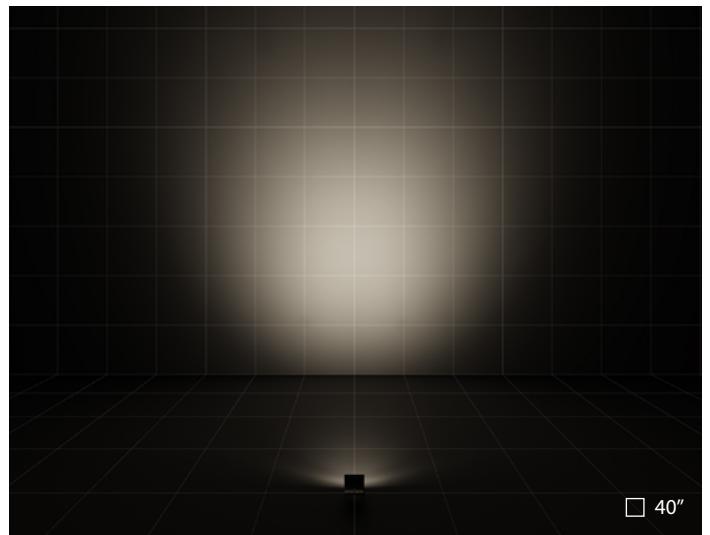

FOCUS+ 2 | C/W 56° Circular Wide optics

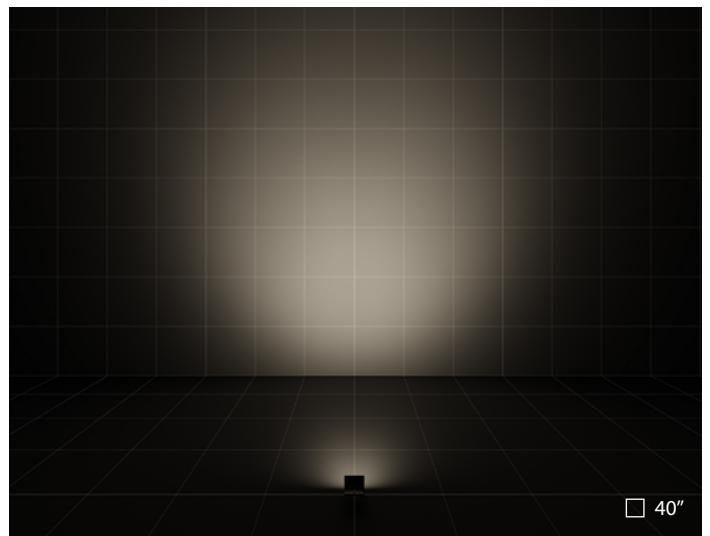

PERFORMANCE
IN LIGHTING

powered by
GEWISS

PERFORMANCE IN LIGHTING
2621 Keys Pointe
Conyers, GA 30013 - United States
Ph 770.822.2115
Fax 770.822.9925

www.performanceinlighting.com