



SHIELD+ | WALL MOUNTED

PRODUCT CODE

PROJECT

TYPE

PERFORMANCE
iN LIGHTING

powered by
GEWISS



Company

Performance in Lighting USA, located in Conyers, GA, is part of an international group of companies headquartered in Verona, Italy.

The group was formed from a number of well-established technical lighting companies from various countries. Performance in Lighting has a wide sales and distribution network operating in over 100 countries worldwide. Production facilities are located in Verona Italy, Bergamo Italy, Goslar Germany, Brussels Belgium, Conyers GA USA. Sales/distribution subsidiaries are located in England, Holland, France, Finland, Spain, Portugal, Australia, Dubai and Japan.

Recognized for its unique professional approach and technical know-how, Performance in Lighting has combined its international experience and technical expertise to become a worldwide leader in its industry. The group offers various lighting solutions worldwide for many applications including interior, exterior, residential, commercial, and sports lighting providing options to satisfy both architectural and engineering requirements.

Performance in Lighting USA concentrates on specification grade luminaires designed to provide a vast array of lighting solutions. Our concentration is outdoor products for illuminating commercial spaces from structural facades to parking areas. We strive to meet the demands of today's lighting community offering made in USA products, European designed with clean, contemporary aesthetics along with aggressive price points and fast lead times.

Pronto Program

PERFORMANCE IN LIGHTING offers a wide range of quick ship fixtures through the Pronto Program and a host of options to fit within the unique budget of your next project.





Overview

Click the QR-code for latest information.

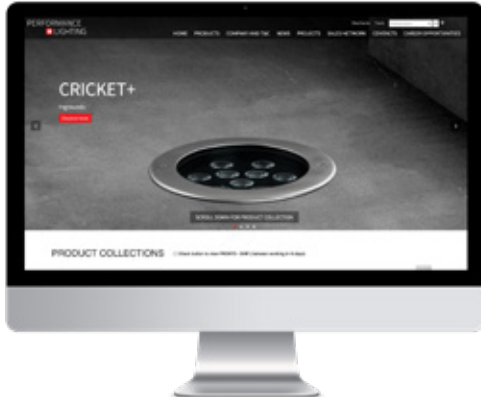

Website

Please visit our web site www.performanceinlighting.com/us/us/ for the latest updated versions available.



5-year warranty

All products are covered by a 5-year warranty, provided that they are used and maintained according to instructions. Focus on quality, safety and product lifetime/longevity are the essential objectives of PERFORMANCE IN LIGHTING. For additional information, email info.usa@pil.lighting

SHIELD+

Sleek wall pack for architectural spaces of all shapes and sizes

The SHIELD+ wall pack series of luminaries was conceived for day to day and specifications projects providing a versatile architectural style ideal for walls, façades, and low-level pathway illumination including stairs. Typical applications include building entrances, multi-use facilities, apartment buildings, institutions, schools, stairways, and loading docks. This series is offered in two sizes and multiple power packages. The ultra-efficient SHIELD+ fixtures with several sensor and control options are built with contractor-friendly installation features such as a universal backbox that adapts to standard junction boxes without the use of adapter plates. The hinged design locks the door in place, allowing precise and stable handling when making the electrical connections. Injection-molded vacuum metalized reflectors provide full-cutoff, no-glare design, and precision optical control. These wall packs are designed for high performance, visual comfort, and have architectural appeal.





SHIELD+

Long-lasting energy-efficient wall pack series. Fixtures consist of:

Construction

- Multi-step powder-coat painting process, optimized against UV rays and corrosion.
- Copper-free (<1%) precision die-cast aluminum housing and mounting plate.
- High-efficiency COB, combined with an optimized passive cooling system, provides a long LED life.
- Specular vacuum metallized polycarbonate reflector provides full-cutoff, no glare design, and precision optical control.
- Extra-clear, tempered, silk-screened, flat glass diffuser.
- Custom molded, anti-aging gasket(s).
- Stainless steel external hardware.

Installation

- Available in two standard sizes of H9" x L8.6" x D4.5" (SHIELD+ 1) and H9" x L14" x D5" (SHIELD+ 2).
- Standard knock-out template for multiple junction box mounting options.
- Suitable for three surface mounted conduit entry points with 1/2" NPS plugs.
- BUTTON and SWIVEL 120-277 V (50 / 60 Hz) photoelectric switch options available (ordered separately).

Optics

- Type III light distribution.

Electrical

- Input voltage: 120-277 V (50 / 60 Hz), integral 0-10 V dimming driver. Optional, integral, emergency battery-pack designed for a minimum operation of 90 minutes (EMPK versions).
- Field settable integral tri-level lumen/wattage packages proprietary DIP switch driver for SHIELD+ 1 (stating factory setting at the lowest level).
- Field settable integral bi-level lumen/wattage packages (37 W / 53 W) proprietary DIP switch driver for SHIELD+ 2 (stating factory setting at the lowest level).

Options

- The luminaire may be configured with numerous options and multiple standard finishes. Not all options are available in all configurations. Consult factory for more information about specification sheet details to build your light.

Listings

- UL Wet location listed. IP66 rated.
- Product meets Buy American Act (BAA) requirements within ARRA.
- Consult factory for which version qualifies for the PRONTO-SHIP program. All Rough-Ins are available to ship within 48-72 hrs. Orders must be marked "PRONTO."
- Photometric data measured according to UNI EN 13032-1/4 and IES LM-79-08
- The light distribution complies with the IESNA Full Cut-Off Classification and is eligible for all "Dark Sky" applications when aimed down.
- Actual performance may differ as a result of the end-user environment and application. All values are design or typical values, measured under laboratory conditions at 25 °C. Specifications are subject to change without notice.

Warranty

- 5-year limited warranty. Complete warranty terms located at www.performanceinlighting.com



SHIELD+ 2



SHIELD+ 1

SHIELD+ 1 / 2



Concealed heat sink thermal management.



Standard knock-out template for multiple junction box mounting.

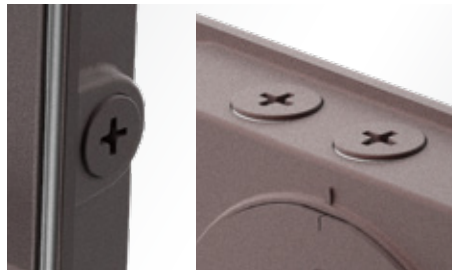

Suitable for conduit entry points with (2 top + 2 side) 1/2" NPS plugs.

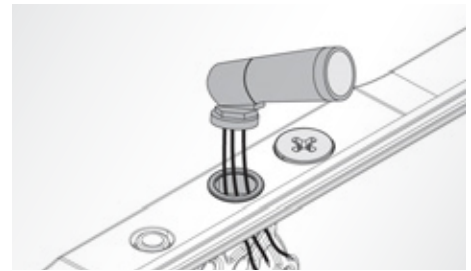

SWIVEL 120-277 V (50 / 60 Hz) photoelectric switch options available (ordered separately).

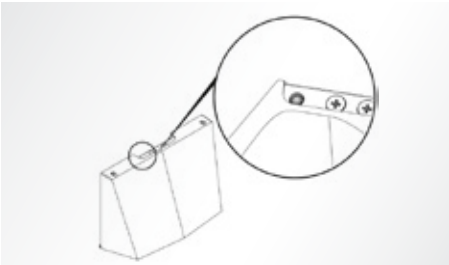

BUTTON 120-277 V (50 / 60 Hz) photoelectric switch options available (ordered separately).

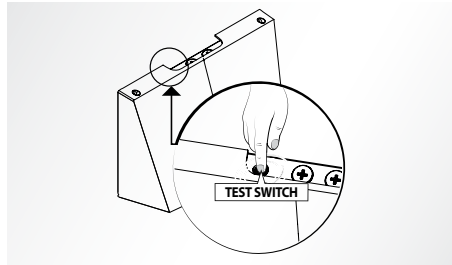

Battery pack test switch (EMP versions).

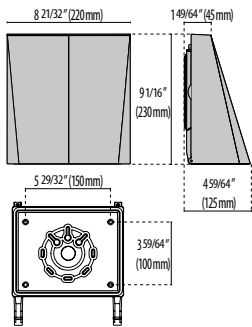

SHIELD+ 1

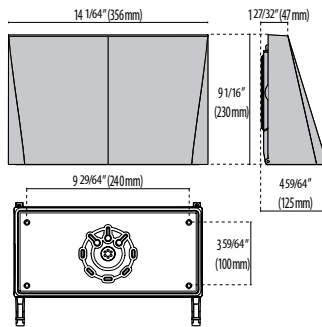

SHIELD+ 2

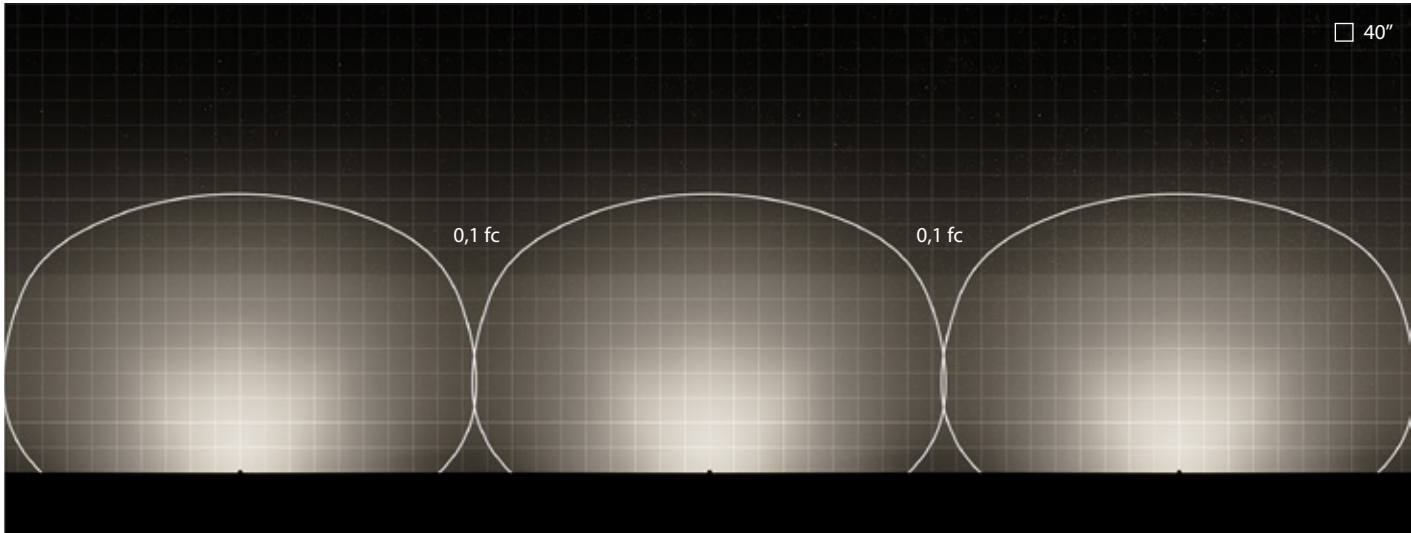

SHIELD+ 1 (27 W) | Asymmetric Extra-Wide optics | TYPE III

Luminaire spacing = 62'4" (19m)
 Path depth = 26'3" (8m)
 Mounting height = 13'1" (4m)

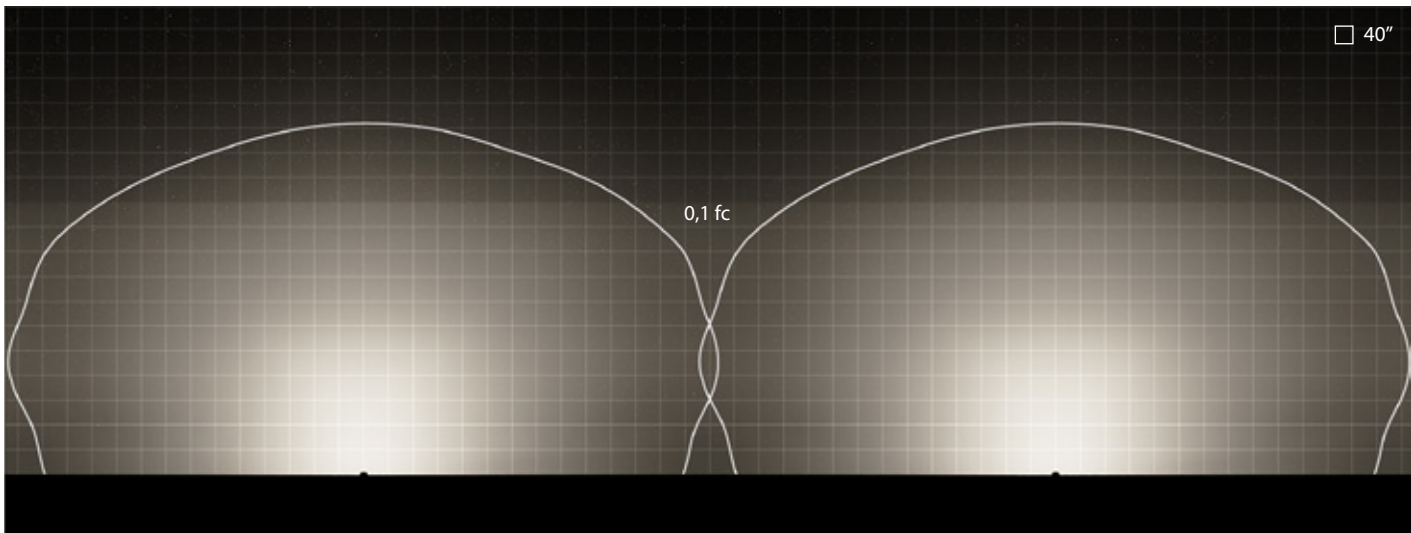

SHIELD+ 2 (80 W) | Asymmetric Extra-Wide optics | TYPE III

Luminaire spacing = 91'10" (28m)
 Path depth = 36'1" (11m)
 Mounting height = 13'1" (4m)

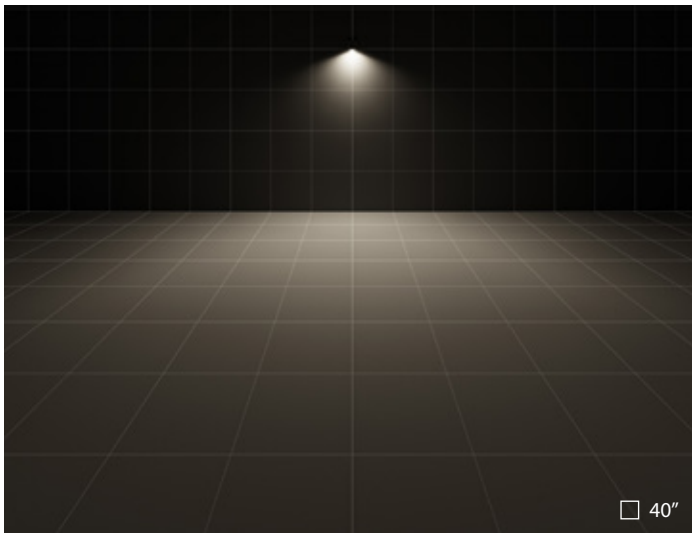

SHIELD+ 1 | Asymmetric Extra-Wide optics | TYPE III

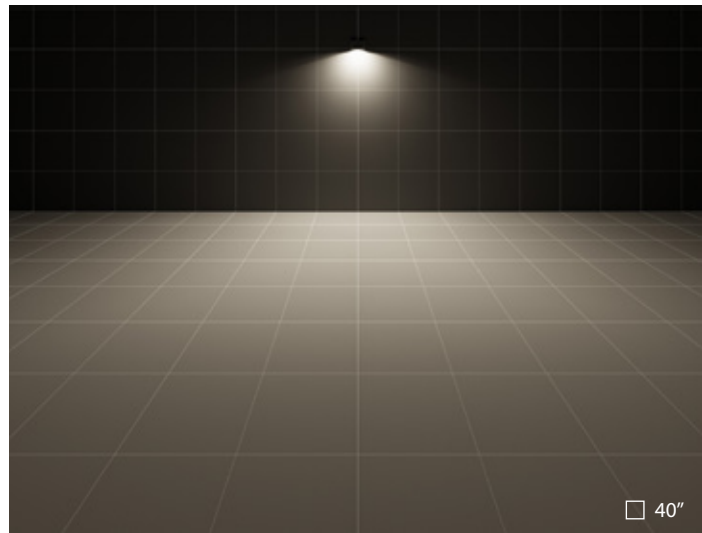

SHIELD+ 2 | Asymmetric Extra-Wide optics | TYPE III

PERFORMANCE
IN LIGHTING

powered by
GEWISS

PERFORMANCE IN LIGHTING
2621 Keys Pointe
Conyers, GA 30013 - United States
Ph 770.822.2115
Fax 770.822.9925

www.performanceinlighting.com