



NIKKO+ | WALL MOUNTED | BOLLARDS

PRODUCT CODE

PROJECT

TYPE

PERFORMANCE
in LIGHTING

powered by
GEWISS



Company

Performance in Lighting USA, located in Conyers, GA, is part of an international group of companies headquartered in Verona, Italy.

The group was formed from a number of well-established technical lighting companies from various countries. Performance in Lighting has a wide sales and distribution network operating in over 100 countries worldwide. Production facilities are located in Verona Italy, Bergamo Italy, Goslar Germany, Brussels Belgium, Conyers GA USA. Sales/distribution subsidiaries are located in England, Holland, France, Finland, Spain, Portugal, Australia, Dubai and Japan.

Recognized for its unique professional approach and technical know-how, Performance in Lighting has combined its international experience and technical expertise to become a worldwide leader in its industry. The group offers various lighting solutions worldwide for many applications including interior, exterior, residential, commercial, and sports lighting providing options to satisfy both architectural and engineering requirements.

Performance in Lighting USA concentrates on specification grade luminaires designed to provide a vast array of lighting solutions. Our concentration is outdoor products for illuminating commercial spaces from structural facades to parking areas. We strive to meet the demands of today's lighting community offering made in USA products, European designed with clean, contemporary aesthetics along with aggressive price points and fast lead times.

Pronto Program

PERFORMANCE IN LIGHTING offers a wide range of quick ship fixtures through the Pronto Program and a host of options to fit within the unique budget of your next project.





Overview

Click the QR-code for latest information.

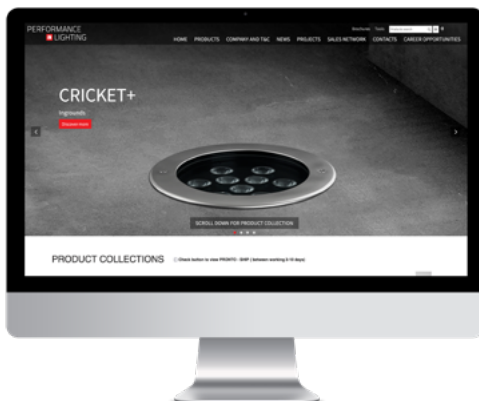

Website

Please visit our web site www.performanceinlighting.com/us/us/ for the latest updated versions available.



5-year warranty

All products are covered by a 5-year warranty, provided that they are used and maintained according to instructions. Focus on quality, safety and product lifetime/longevity are the essential objectives of PERFORMANCE IN LIGHTING. For additional information, email info.usa@pil.lighting

NIKKO+

No shadows. Just light.

A versatile series of wall luminaires in anti-corrosion die-cast aluminum, with satin pressed glass diffusers with a frosted internal surface. NIKKO+ is available in three different sizes, with faceplates to protect the diffuser or modify the light output. The luminaire can also be post mounted: posts are extruded aluminum in three different heights, designed to hold one or two luminaires. The post is designed to perfectly integrate the fixtures. The series offers a broad range of lighting solutions for gardens and for entryways to residential, commercial or public buildings. With a 10-year glass warranty and the various covers/grills, this series is a winner every time.





Apartment building De Boel | Amsterdam | Netherlands

Surface-mount doorway and hallway lights and post mount series. Fixtures consist of:

CONSTRUCTION

- Multi-step powder-coat painting process, optimized against UV rays and corrosion.
- Copper-free die-cast aluminum housing, ring, and faceplates.
- Copper-free aluminum extruded post.
- High transmittance, internally coated, pressed glass diffuser, thermally, and chemically quenched to strengthen the impact resistance and reduce the effect of rapid temperature changes.
- Custom MCPCB utilized to maximize heat dissipation and promote a long LED lifespan (NIKKO+ 45). High-efficiency COB, combined with an optimized passive cooling system, provides a long LED lifespan (NIKKO+ 21 / 27).
- Custom molded, anti-aging gasket(s).
- Stainless steel external hardware.

INSTALLATION

- Available in three standard sizes of H8.4" x L5.8" (NIKKO+ 21), H10.8" x L7.2" (NIKKO+ 27) , H16.7" x L5.8" (NIKKO+ 45) with ring, grill (G), or visa (V) faceplate. Overall depth is x 5.2" - 5.6".
- Wall bracket and post accessories available (ordered separately).

OPTICS

- 100% uniform diffused light emission.

ELECTRICAL

- Input voltage: 120-277 V (50 / 60 Hz), integral driver.

OPTIONS

- The luminaire may be configured with numerous options and multiple standard finishes. Not all options are available in all configurations. Consult factory for more information about specification sheet details.

LISTINGS

- UL Wet location listed. IP65 rated.
- Product meets Buy American requirements within ARRA.
- Photometric data measured according to UNI EN 13032-1/4 and IES LM-79-08
- Actual performance may differ as a result of the end-user environment and application. All values are design or typical values, measured under laboratory conditions at 25 °C. Specifications are subject to change without notice.

WARRANTY

- 10-year glass warranty.
- 5-year limited warranty. Complete warranty terms located at www.performanceinlighting.com



NIKKO+ 45



NIKKO+ 27



NIKKO+ 21



NIKKO+ 27 LA



NIKKO+ 21 LA

NIKKO+21 LA / 27 LA



High transmittance, internally coated, pressed glass diffuser, thermally, and chemically quenched to strengthen the impact resistance and reduce the effect of rapid temperature changes.

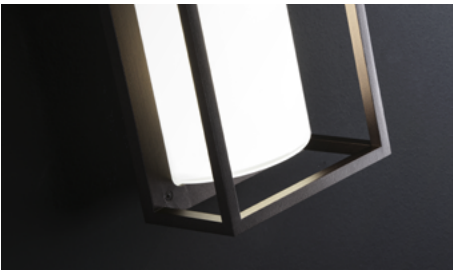

100% uniform diffused light emission.



NIKKO+27 LA with E26 lampholder versions available

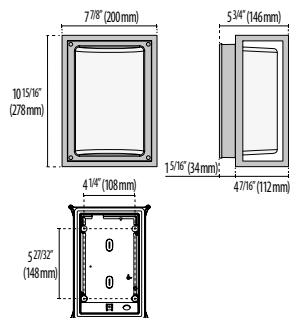
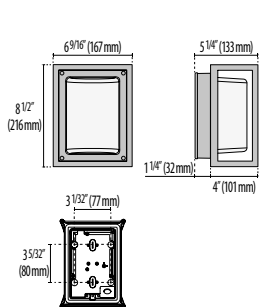

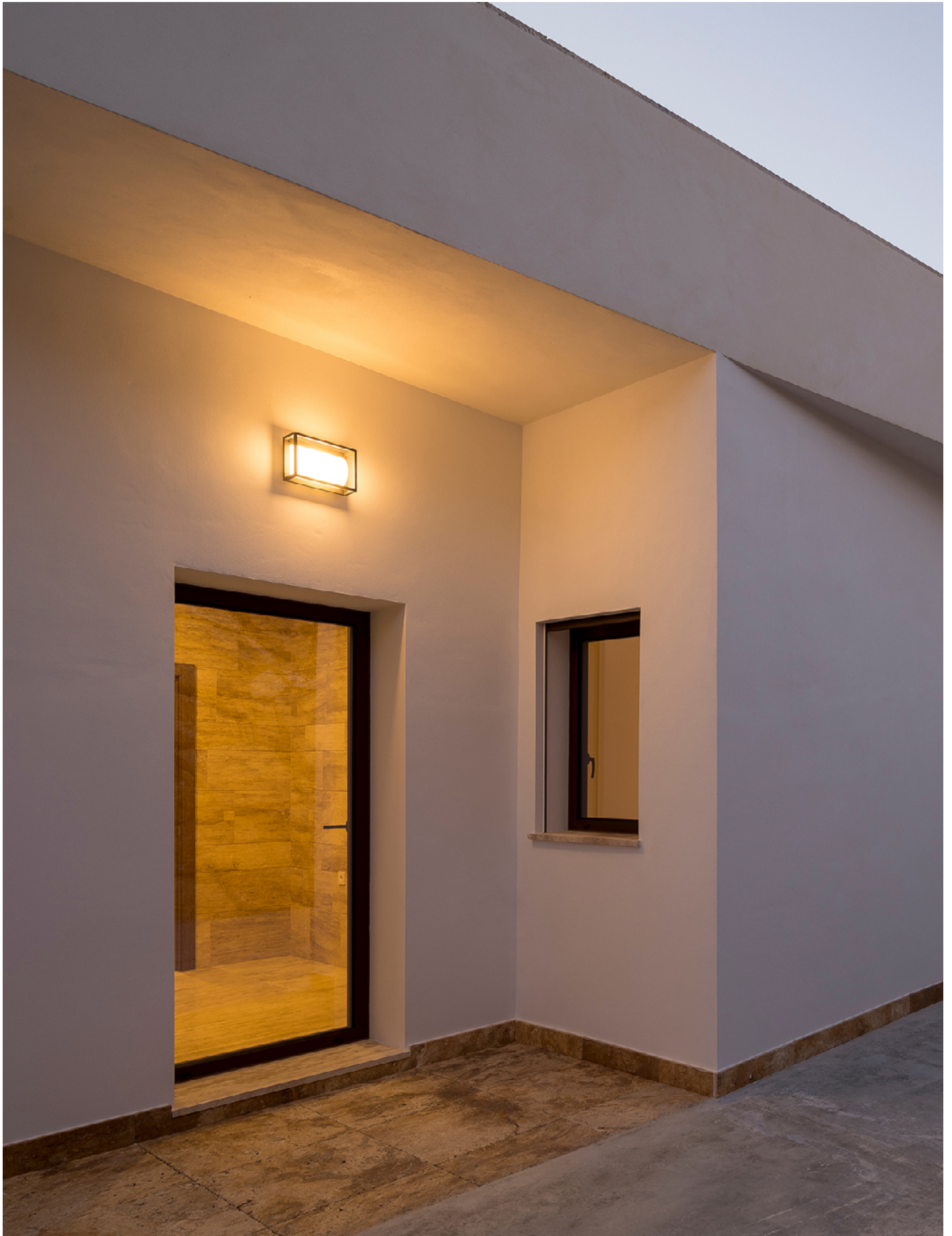

Private villa | Almería | Spain

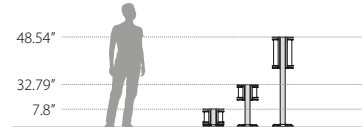

100% uniform diffused light emission.



Available with three trim styles: standard, grill (/G) or visa (/V). Overall dimensions are H8.4" x L5.8" (NIKKO+ 21).



Available with three trim styles: standard, grill (/G) or visa (/V). Overall dimensions are H10.8" x L7.2" (NIKKO+ 27).

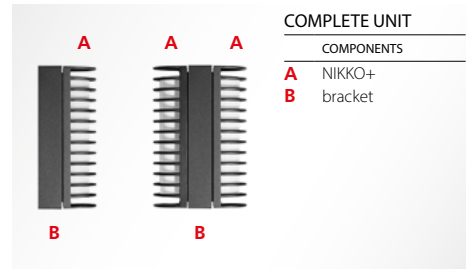

For products that must be mounted on a post, bracket, track or recessed into the wall, it is often necessary to order several different parts (codes) to get the complete configuration.

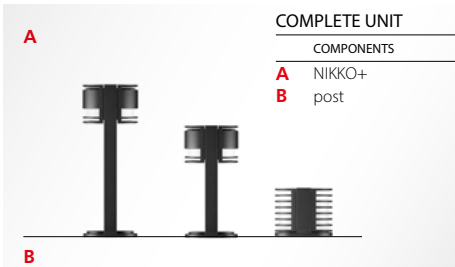

For products that must be mounted on a post, bracket, track or recessed into the wall, it is often necessary to order several different parts (codes) to get the complete configuration.

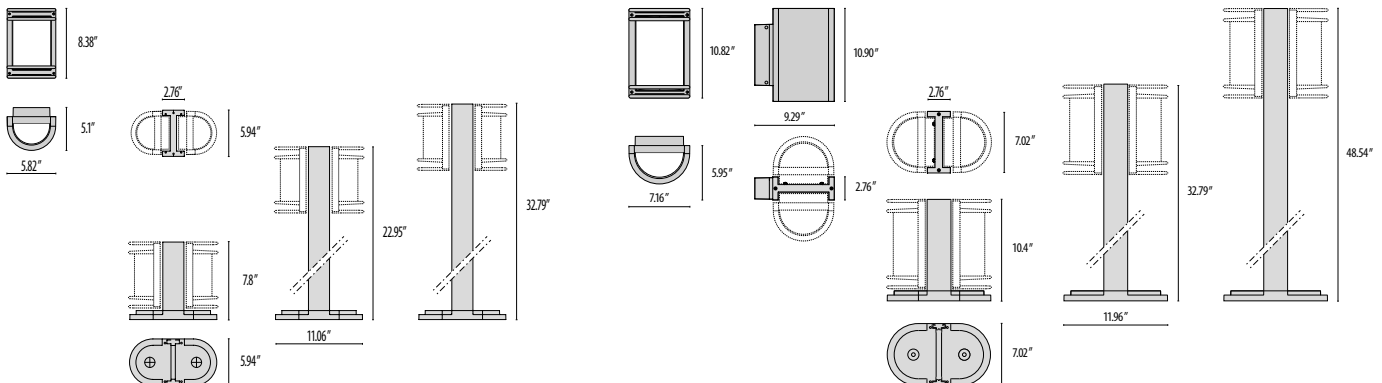



NIKKO+ 45

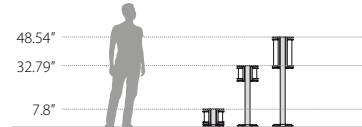
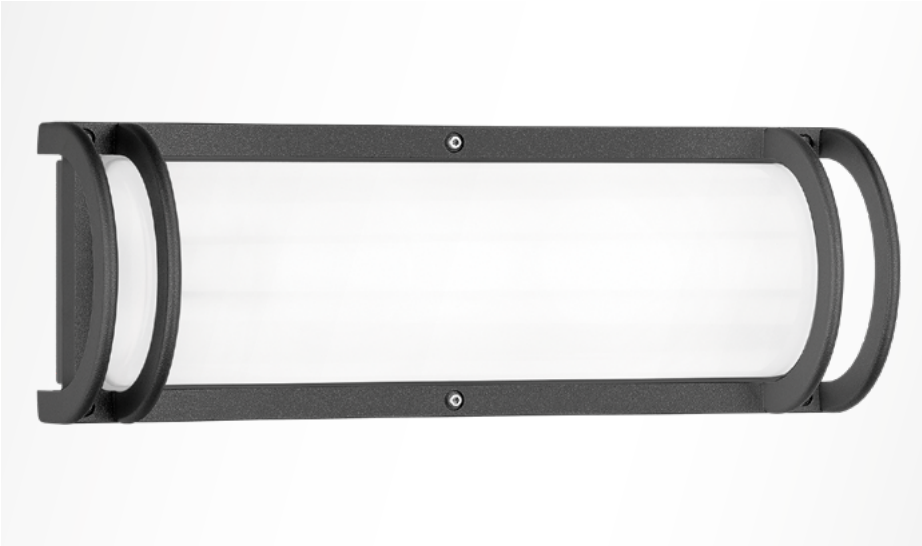

100% uniform diffused light emission.



Available with two trim styles: standard and grill (/G). Overall dimensions are H16.7" x L5.8" (NIKKO+ 45).

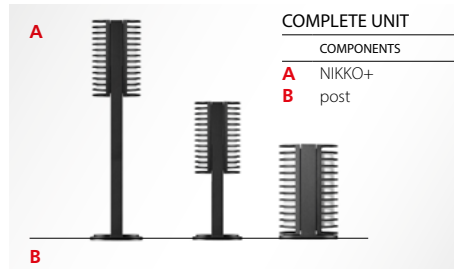

For products that must be mounted on a post, bracket, track or recessed into the wall, it is often necessary to order several different parts (codes) to get the complete configuration.

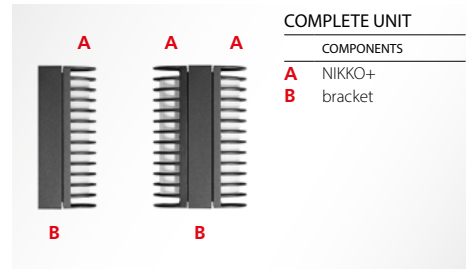

For products that must be mounted on a post, bracket, track or recessed into the wall, it is often necessary to order several different parts (codes) to get the complete configuration.

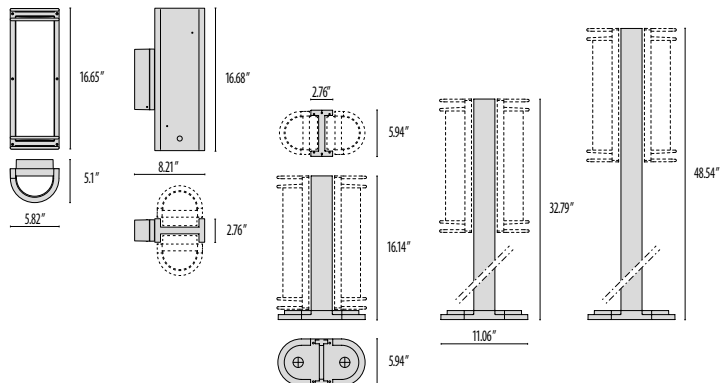



Apartment building De Boel | Amsterdam | Netherlands

PERFORMANCE
IN LIGHTING

powered by
GEWISS

PERFORMANCE IN LIGHTING
2621 Keys Pointe
Conyers, GA 30013 - United States
Ph 770.822.2115
Fax 770.822.9925

www.performanceinlighting.com