



TYK+ | FLOODLIGHT | WALL MOUNTED | AREA LIGHTING

PRODUCT CODE

PROJECT

TYPE

PERFORMANCE
in LIGHTING

powered by
GEWISS



Company

Performance in Lighting USA, located in Conyers, GA, is part of an international group of companies headquartered in Verona, Italy.

The group was formed from a number of well-established technical lighting companies from various countries. Performance in Lighting has a wide sales and distribution network operating in over 100 countries worldwide. Production facilities are located in Verona Italy, Bergamo Italy, Goslar Germany, Brussels Belgium, Conyers GA USA. Sales/distribution subsidiaries are located in England, Holland, France, Finland, Spain, Portugal, Australia, Dubai and Japan.

Recognized for its unique professional approach and technical know-how, Performance in Lighting has combined its international experience and technical expertise to become a worldwide leader in its industry. The group offers various lighting solutions worldwide for many applications including interior, exterior, residential, commercial, and sports lighting providing options to satisfy both architectural and engineering requirements.

Performance in Lighting USA concentrates on specification grade luminaires designed to provide a vast array of lighting solutions. Our concentration is outdoor products for illuminating commercial spaces from structural facades to parking areas. We strive to meet the demands of today's lighting community offering made in USA products, European designed with clean, contemporary aesthetics along with aggressive price points and fast lead times.

Pronto Program

PERFORMANCE IN LIGHTING offers a wide range of quick ship fixtures through the Pronto Program and a host of options to fit within the unique budget of your next project.





Overview

Click the QR-code for latest information.

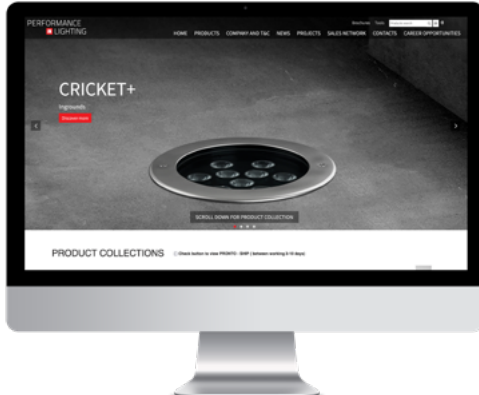

Website

Please visit our web site www.performanceinlighting.com/us/us/ for the latest updated versions available.



5-year warranty

All products are covered by a 5-year warranty, provided that they are used and maintained according to instructions. Focus on quality, safety and product lifetime/longevity are the essential objectives of PERFORMANCE IN LIGHTING. For additional information, email info.usa@pil.lighting

Shape the nocturnal soul of architecture

The TYK+ is the quintessence of the structural development in the outdoor architectural field of PERFORMANCE IN LIGHTING. Beauty and essential design, where the proportions remain consistent in the series' different sizes, enrich the luminaire's technical soul. The core of TYK+ is an elegant mix of how to harness the latest technology available and light architecture professionally. Each custom-designed optics has its required effect to ensure an exceptionally sharp, homogenous, and supremely comfortable light beam.

TYK+ is a "universal" architectural lighting tool: it allows the designer to illuminate horizontal and vertical planes with absolute precision, dose light and shadow in a targeted way, and alternate light and dark areas by composing them successfully.

These architectural series also offer additional RGBW color mixing options for high emotional impact scenographic effects and dynamic Tunable White (TW) for smooth variations in color temperature in response to how a space is used.





Long-lasting energy-efficient flood and accent light series for lighting landscape and any architecture, also applying dynamic color.

Construction

- Copper-free precision die-cast aluminum housing, and adjustable stainless steel mounting bracket.
- Multi-step powder-coat painting process, optimized against UV rays and corrosion.
- Custom MCPCB utilized to maximize heat dissipation and promote long LED life.
- High-transmittance transparent optics.
- Custom molded, anti-aging gasket(s).
- Stainless steel external hardware.
- Extra-clear, tempered, silk-screened, flat glass diffuser.
- Stainless steel graduated ferrules for aiming purposes on both sides of the fixture.

Installation

- The TYK+ 10 RM versions to be powered solely with the power supply units available as accessories (ordered separately).
- Maximum cable length of 10 meters between the power supply unit and the related floodlights.
- RM (Remote Driver) version are granted for a – 40°F working temperature.

Optics

- Circular Intensive (C/I) Medium (C/M), NEMA 5H x 5V (C/IW), Elliptical (ELL), color mixing (RGBW), dynamic Tunable White (TW) optics, and light distributions.
- RGBW (4000K) color mixing for high emotional impact scenographic effects.
- Dynamic Tunable White (TW) options enable smooth variations in color temperature, from 2700K to 5700K, in response to how a space is used.

Electrical

- Input voltage: 120 V (50 / 60 Hz), integral driver (TYK+ 10), and 120-277 V (50 / 60 Hz), integral 1-10 V dimming driver (TYK+ 20/30). 48 V DC, separate driver for RGBW color mixing and dynamic TW models (ordered separately).

Options

- The luminaire may be configured with numerous options and multiple standard finishes. Not all options are available in all configurations. Consult factory for more information about specification sheet details.

Listings

- UL Wet location listed. IP66 rated.
- Product meets Buy American Act (BAA) requirements within ARRA.
- Photometric data measured according to UNI EN 13032-1/4 and IES LM-79-08
- Actual performance may differ as a result of the end-user environment and application. All values are design or typical values, measured under laboratory conditions at 25 °C. Specifications are subject to change without notice.

Warranty

- 5-year limited warranty. Complete warranty terms located at www.performanceinlighting.com



TYK+ 10



TYK+ 20



TYK+ 30



reddot winner 2021



High-transparency polycarbonate optics provide an optimized light transmission. Die-cast aluminium housing, powder-polyester coated ISO 9227.



Graduated goniometer for aiming purposes made in stainless steel



Tear-proof nickel-plated brass cable gland M16x1.5 for cables Ø 5 mm- Ø 10 mm



Standard robust 1/2" NPS knuckle mount with 180° adjustable swivel arm (SA versions) and rugged, locking teeth for a simplified installation.

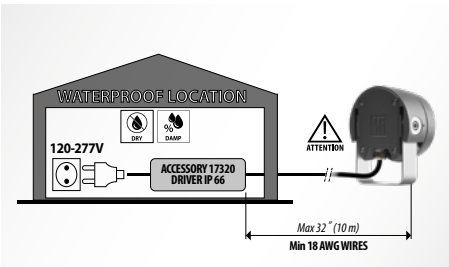

The TYK+ 10 RM versions to be powered solely with the power supply units available as accessories (ordered separately).

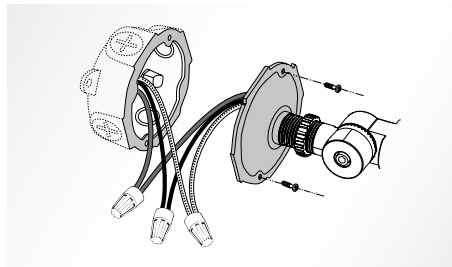

Junction box - cover plate (by others)



JBox cover plate - Iron gray

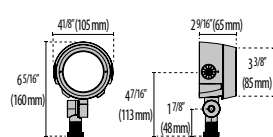
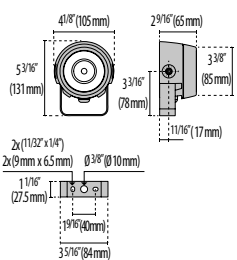

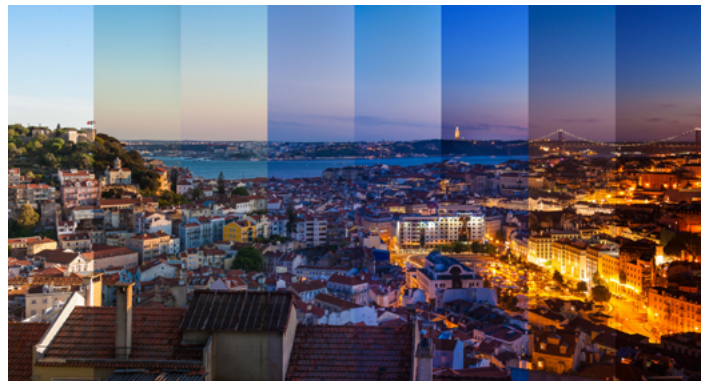

RGBW

Tunable White

TYK+ 10

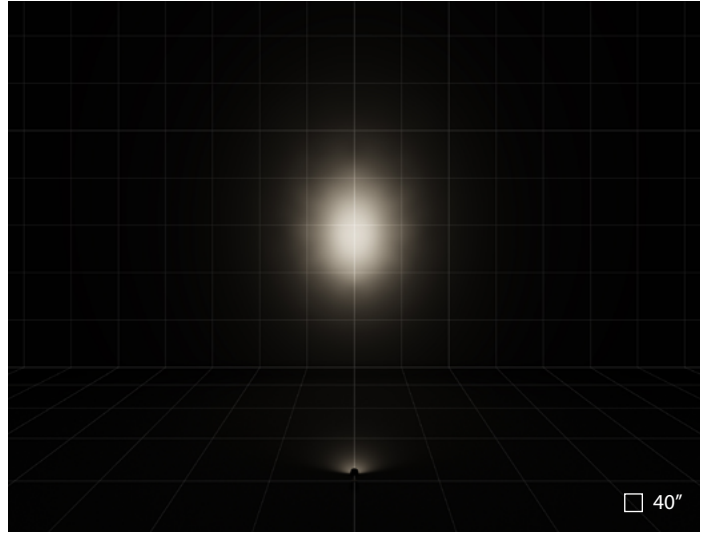
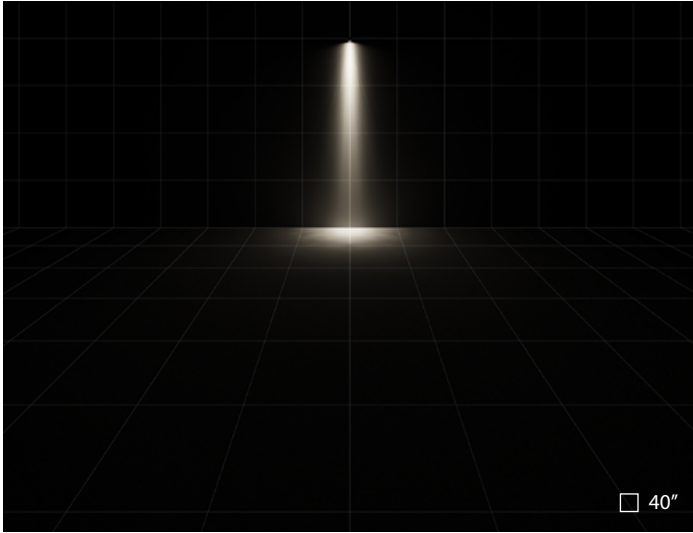

TYK+ 10 | C/I 10° Circular Intensive optics | NEMA 3H x 3V

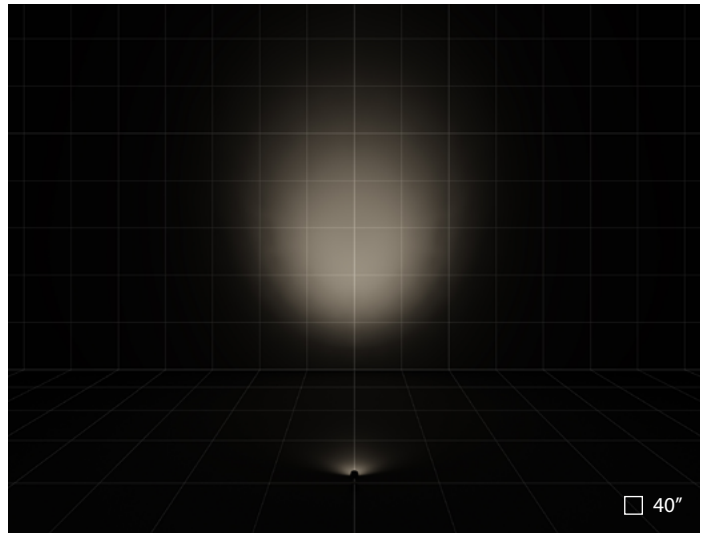
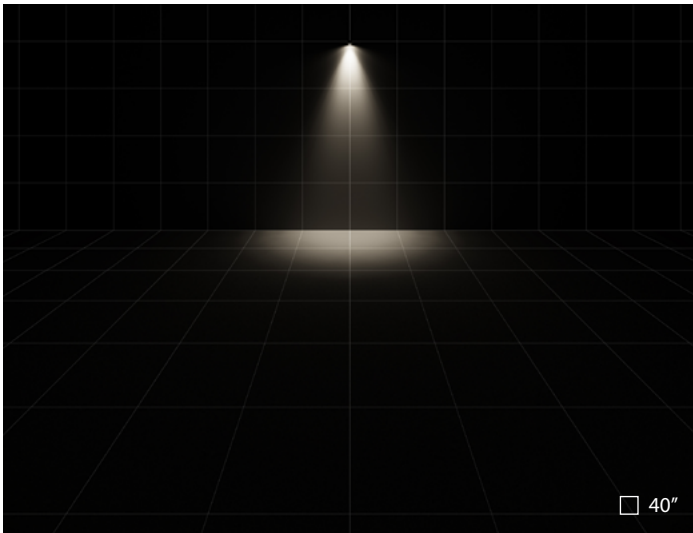

TYK+ 10 | C/M 34° Circular Medium optics | NEMA 4H x 4V

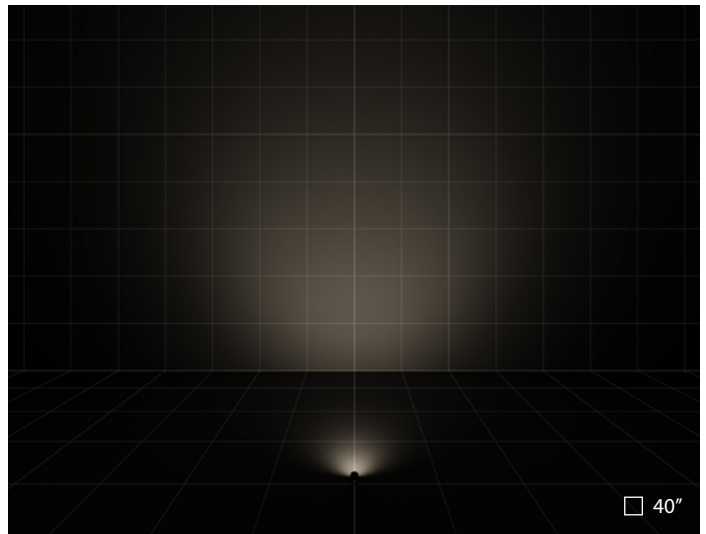
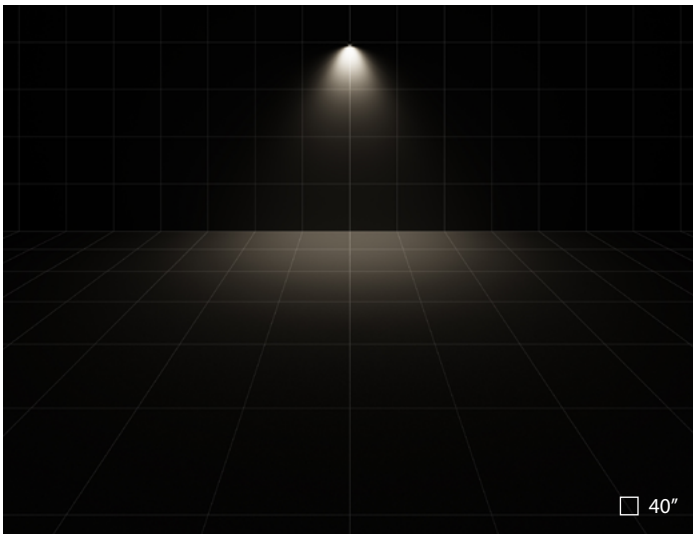

TYK+ 10 | C/IW 65° Circular Intensive-Wide optics | NEMA 5H x 5V

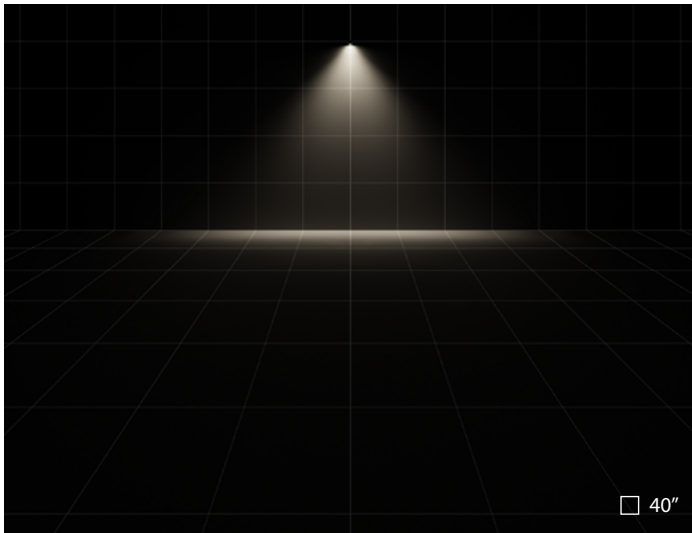

TYK+ 10 | ELL 9°x70° Elliptical optics | NEMA 4H x 3V

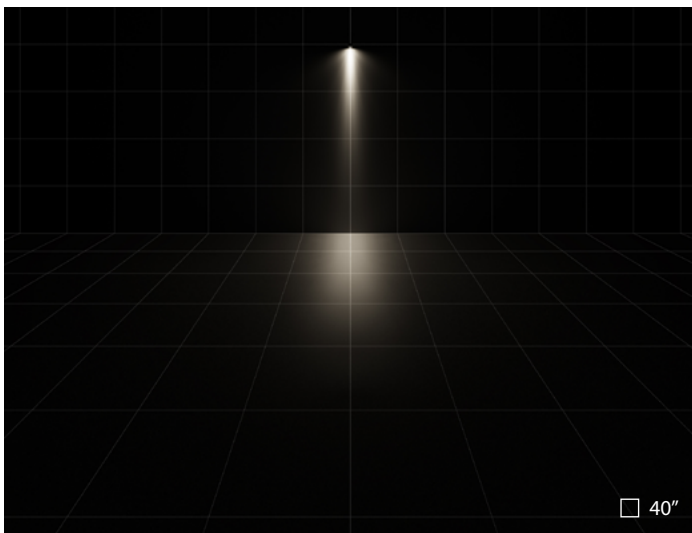
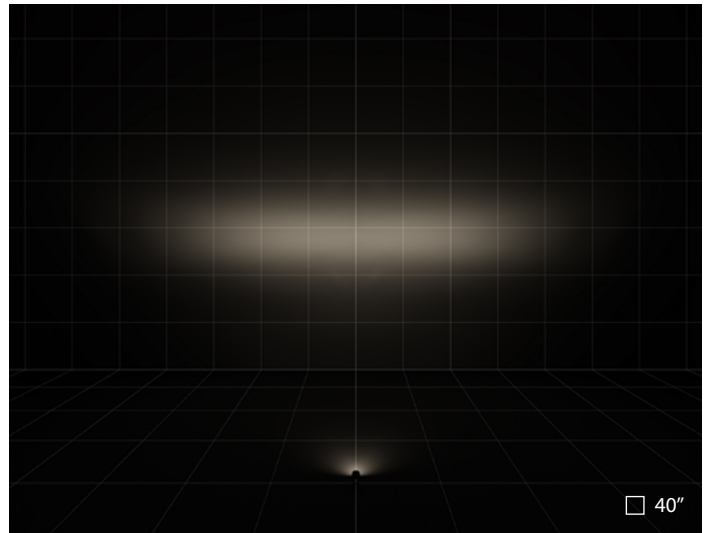

TYK+ 10 | ELL 70°x9° Elliptical optics | NEMA 4H x 3V

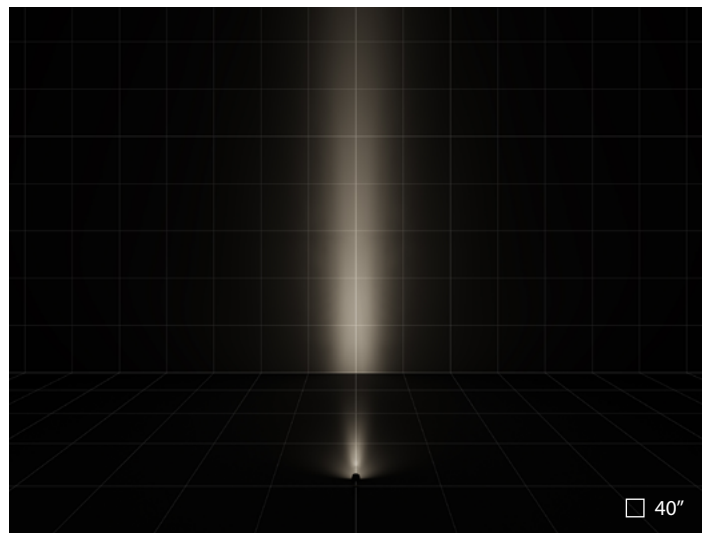

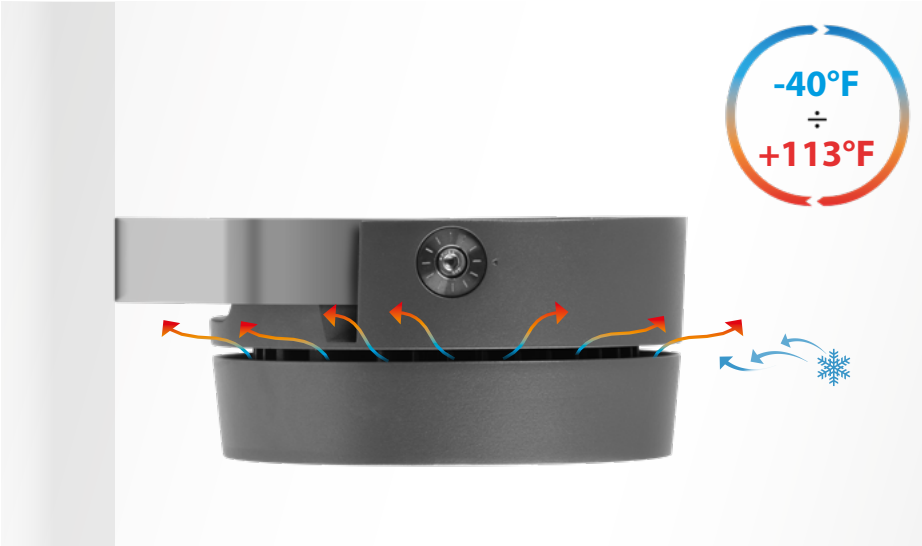

Luminaire designed with two separate die-cast aluminium compartments to maximise heat dissipation between electronic components and the LEDs, powder-polyester coated ISO 9227



High-transparency polycarbonate optics provide an optimized light transmission.



Graduated goniometer for aiming purposes made in stainless steel



Tear-proof nickel-plated brass cable gland M20x1.5 for cables Ø 10 mm- Ø 14 mm



JBox cover plate - Iron gray



The snoot accessory is compatible with versions that have C/I narrow-beam lenses



Gliding support made of painted aluminium for the installation on 60-76 mm Ø posts. 2 opposed luminaires

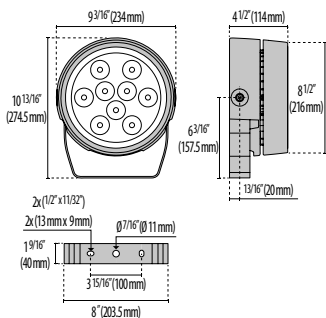



RGBW

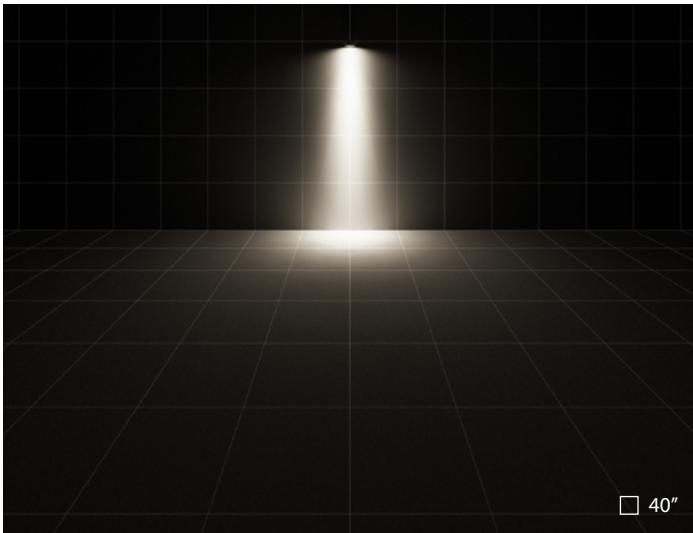

TYK+ 20 | C/I 10° Circular Intensive optics | NEMA 3H x 3V

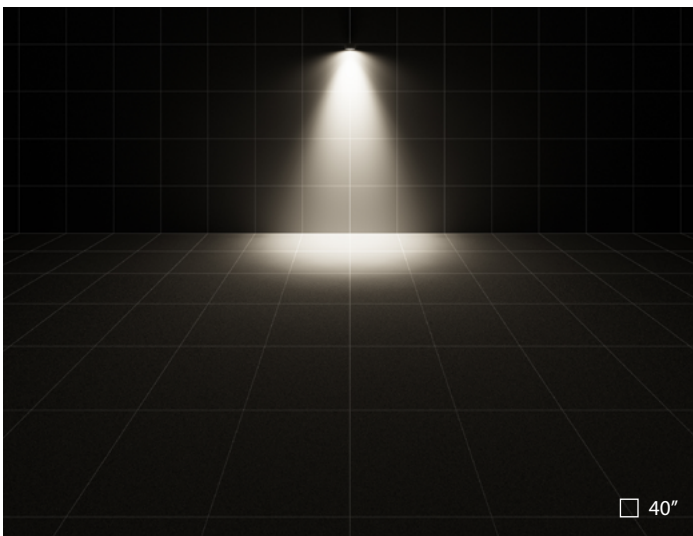
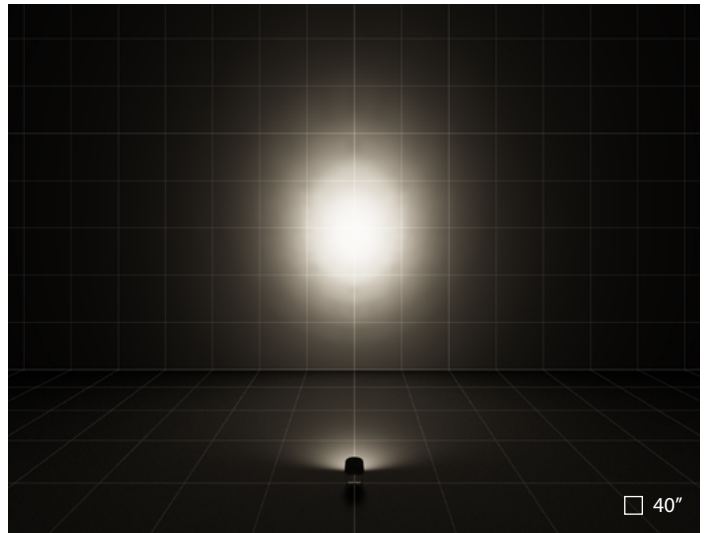

TYK+ 20 | C/M 34° Circular Medium optics | NEMA 4H x 4V

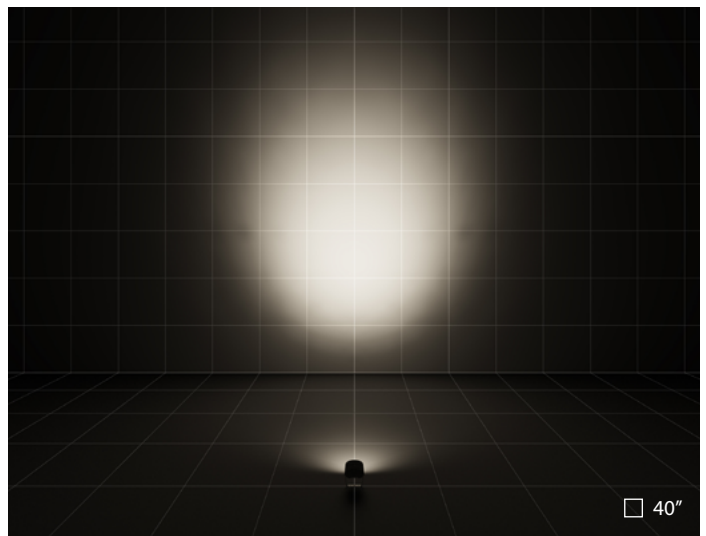

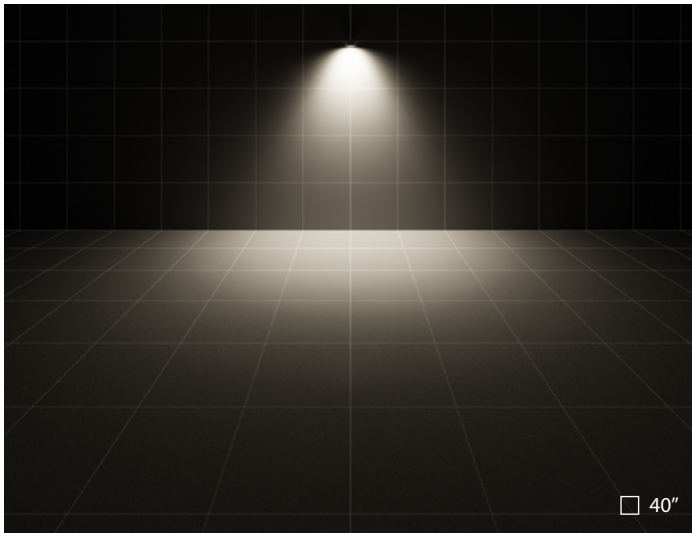

TYK+ 20 | C/IW 65° Circular Intensive-Wide optics | NEMA 5H x 5V

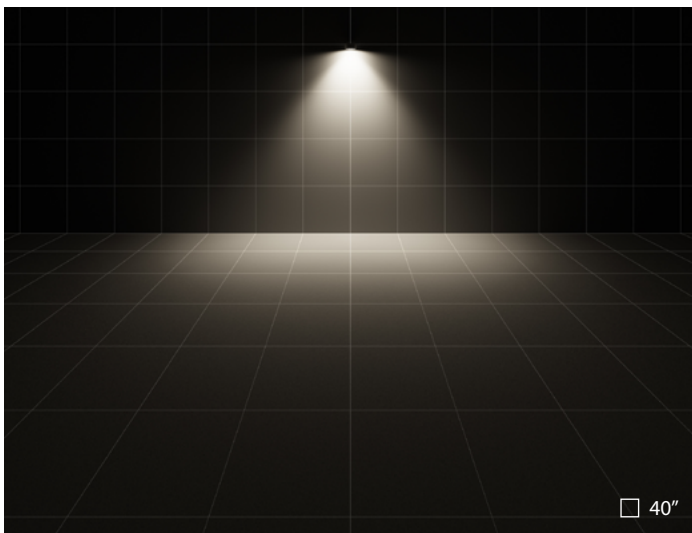
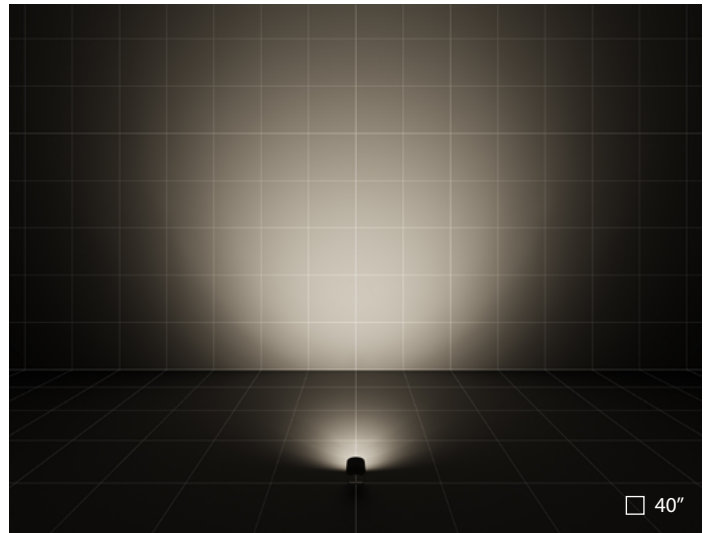

TYK+ 20 | ELL 35°x65° Elliptical optics | NEMA 4H x 3V

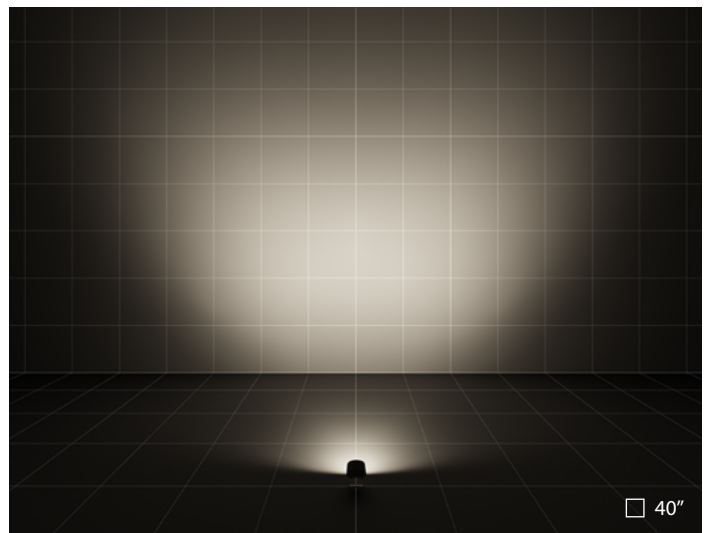

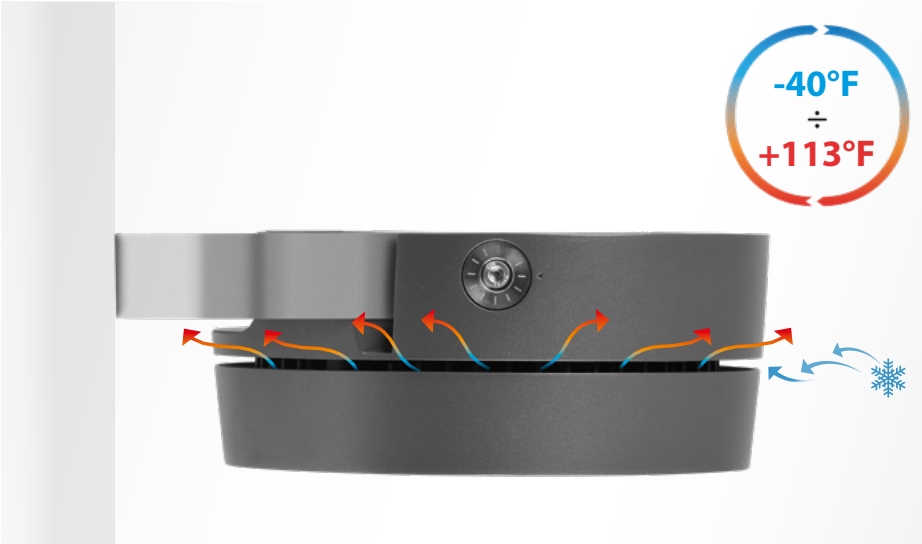

Luminaire designed with two separate die-cast aluminium compartments to maximise heat dissipation between electronic components and the LEDs, powder-polyester coated ISO 9227



High-transparency polycarbonate optics provide an optimized light transmission.

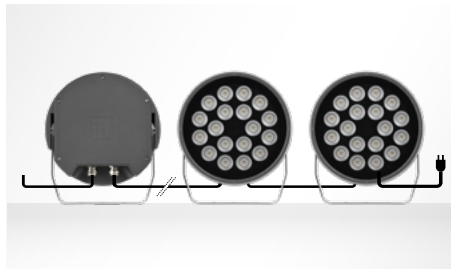

Each luminaire is supplied with two IP 68 cable glands allowing a single or a through power connection



JBox cover plate - Iron gray



Extra rotation bracket +55°/-90°



Barndoor (consult factory)



Gliding support made of painted aluminium for the installation on 90 mm Ø posts. 2 opposed luminaires

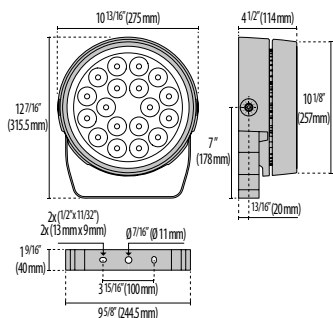



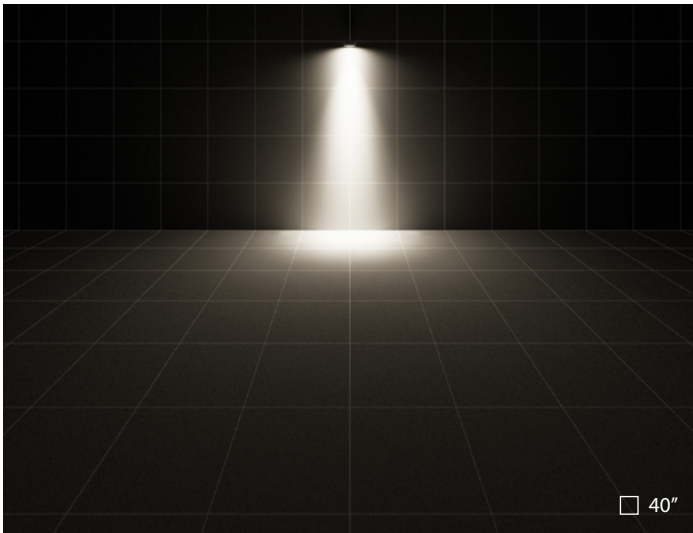

□ 40"

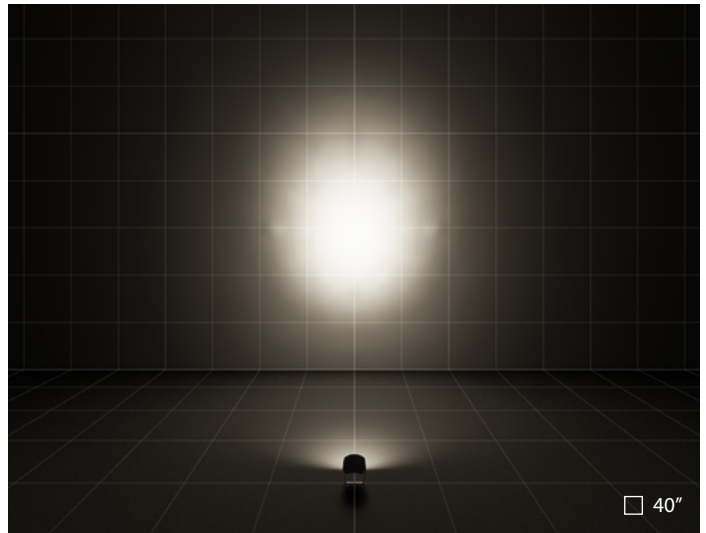

□ 40"

TYK+ 30 | C/I 10° Circular Intensive optics | NEMA 3H x 3V

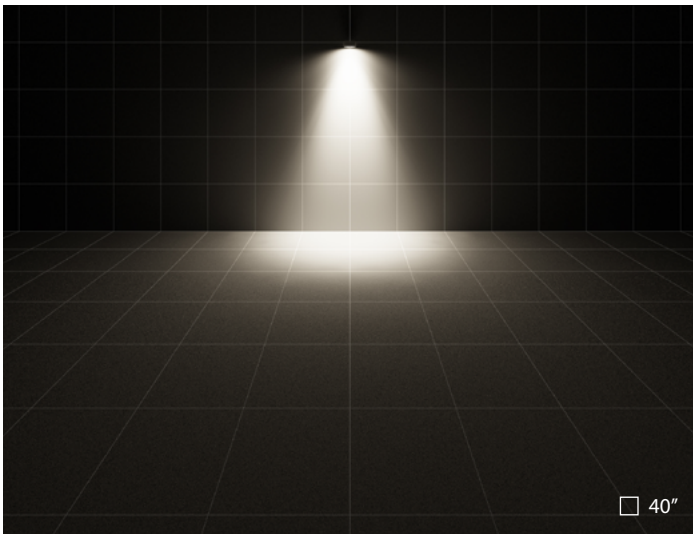

□ 40"

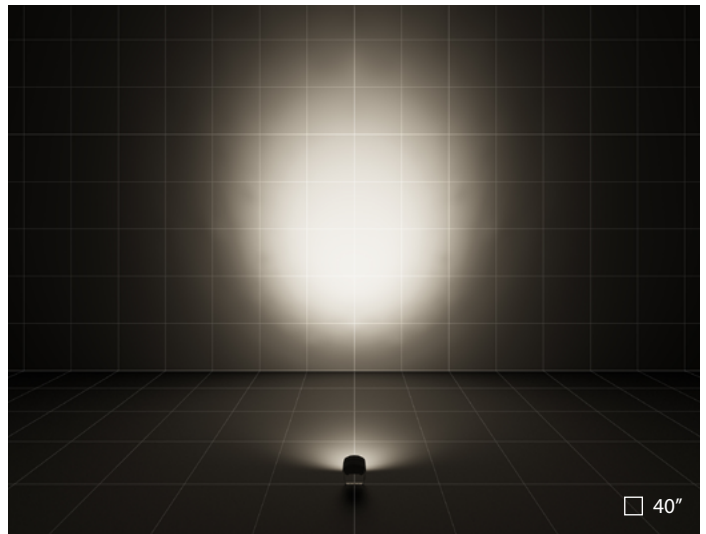

□ 40"

TYK+ 30 | C/M 34° Circular Medium optics | NEMA 4H x 4V

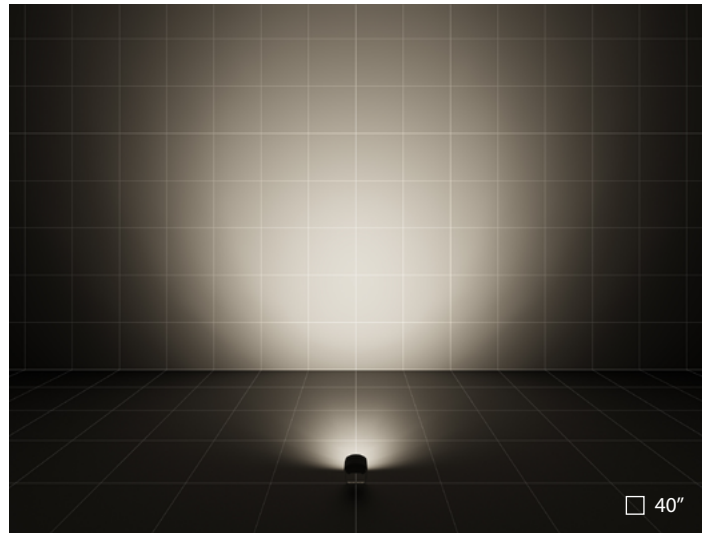
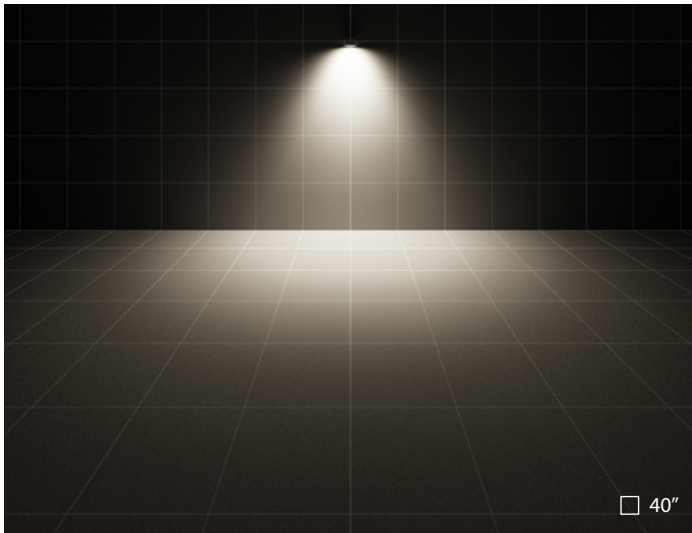

TYK+ 30 | C/IW 65° Circular Intensive-Wide optics | NEMA 5H x 5V

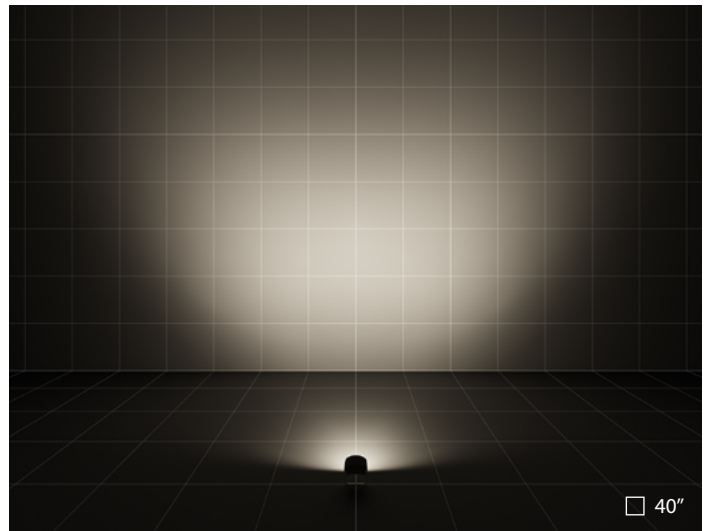
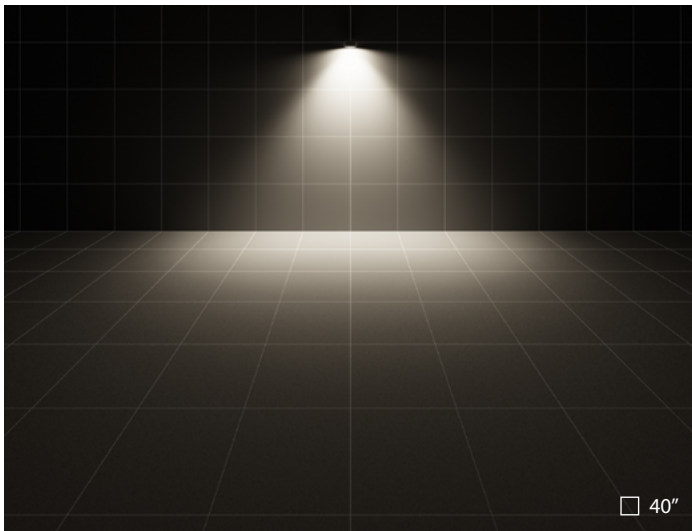

TYK+ 30 | ELL 35°x65° Elliptical optics | NEMA 4H x 3V

PERFORMANCE
IN LIGHTING

powered by
GEWISS

PERFORMANCE IN LIGHTING
2621 Keys Pointe
Conyers, GA 30013 - United States
Ph 770.822.2115
Fax 770.822.9925

www.performanceinlighting.com